

SUN5000-(8K, 12K)-MAP0 Series

User Manual

Issue 07
Date 2025-07-25



Copyright © Huawei Digital Power Technologies Co., Ltd. 2025. All rights reserved.

No part of this document may be reproduced or transmitted in any form or by any means without prior written consent of Huawei Digital Power Technologies Co., Ltd.

Trademarks and Permissions



HUAWEI and other Huawei trademarks are the property of Huawei Technologies Co., Ltd.

All other trademarks and trade names mentioned in this document are the property of their respective holders.

Notice

The purchased products, services and features are stipulated by the contract made between Huawei Digital Power Technologies Co., Ltd. and the customer. All or part of the products, services and features described in this document may not be within the purchase scope or the usage scope. Unless otherwise specified in the contract, all statements, information, and recommendations in this document are provided "AS IS" without warranties, guarantees or representations of any kind, either express or implied. The information in this document is subject to change without notice. Every effort has been made in the preparation of this document to ensure accuracy of the contents, but all statements, information, and recommendations in this document do not constitute a warranty of any kind, express or implied.

Huawei Digital Power Technologies Co., Ltd.

Address: Huawei Digital Power Antuoshan Headquarters
Futian, Shenzhen 518043
People's Republic of China

Website: <https://digitalpower.huawei.com>

About This Document

Purpose

This document describes the following inverter models (also referred to as SUN5000) in terms of the safety precautions, product introduction, installation, electrical connections, power-on and commissioning, maintenance, and technical specifications. Read this document carefully before installing and operating the inverter.

- SUN5000-8K-MAP0
- SUN5000-12K-MAP0




Intended Audience



This document is intended for:

- Technical support engineers
- Hardware installation engineers
- Commissioning engineers
- Maintenance engineers

Symbol Conventions

The symbols that may be found in this document are defined as follows.

Symbol	Description
 DANGER	Indicates a hazard with a high level of risk which, if not avoided, will result in death or serious injury.
 WARNING	Indicates a hazard with a medium level of risk which, if not avoided, could result in death or serious injury.
 CAUTION	Indicates a hazard with a low level of risk which, if not avoided, could result in minor or moderate injury.

Symbol	Description
 NOTICE	Indicates a potentially hazardous situation which, if not avoided, could result in equipment damage, data loss, performance deterioration, or unanticipated results. NOTICE is used to address practices not related to personal injury.
 NOTE	Supplements the important information in the main text. NOTE is used to address information not related to personal injury, equipment damage, and environment deterioration.

Change History

Changes between document issues are cumulative. The latest document issue contains all the changes made in earlier issues.

Issue 07 (2025-07-25)

- Updated [2.2 Networking Application](#).
- Updated [5.2 Preparing Cables](#).
- Updated [5.7 Connecting Signal Cables](#).
- Updated [5.7.2 Connecting RS485 Communications Cables \(Power Meter\)](#).
- Updated [9 Technical Specifications](#).

Issue 06 (2025-07-01)

- Updated [7.2.5 Limit on Power Purchased from Grid](#).
- Updated [7.3.6 Limit on Power Purchased from Grid](#).
- Added [7.2.8 Resetting the Password for Logging In to the Local Commissioning Screen](#).
- Added [7.3.9 Resetting the Password for Logging In to the Local Commissioning Screen](#).

Issue 05 (2025-04-16)

- Updated [5.2 Preparing Cables](#).
- Added [7.2.5 Limit on Power Purchased from Grid](#).
- Added [7.3.6 Limit on Power Purchased from Grid](#).
- Updated [9 Technical Specifications](#).

Issue 04 (2024-11-12)

- Updated [5.7.8 Connecting the Battery Signal Cable](#).
- Updated [I Certificate Management and Maintenance](#).

Issue 03 (2024-08-31)

Updated [A Grid Codes](#).

Issue 02 (2024-07-19)

- Updated [5.2 Preparing Cables](#).
- Updated [5.4 Connecting an AC Output Power Cable](#).
- Updated [5.7.8 Connecting the Battery Signal Cable](#).
- Updated [7.3.5 DRM \(Australia AS 4777\)](#).
- Updated [9 Technical Specifications](#).
- Updated [A Grid Codes](#).

Issue 01 (2024-05-13)

This issue is the first official release.

Contents

About This Document.....	ii
1 Safety Information.....	1
1.1 Personal Safety.....	2
1.2 Electrical Safety.....	4
1.3 Environment Requirements.....	7
1.4 Mechanical Safety.....	8
2 Overview.....	13
2.1 Model Number Description.....	13
2.2 Networking Application.....	14
2.3 Appearance.....	21
2.4 Working Modes.....	23
2.5 Label Description.....	25
3 Storage Requirements.....	28
4 Installation.....	29
4.1 Installation Modes.....	29
4.2 Installation Requirements.....	29
4.2.1 Site Selection Requirements.....	29
4.2.2 Clearance Requirements.....	30
4.2.3 Angle Requirements.....	32
4.3 Tools.....	33
4.4 Checking Before the Installation.....	35
4.5 Moving the Inverter.....	35
4.6 Installing the Inverter on a Wall.....	36
4.7 Installing the Inverter on a Support.....	38
5 Electrical Connections.....	41
5.1 Precautions.....	41
5.2 Preparing Cables.....	42
5.3 Connecting a PE Cable.....	46
5.4 Connecting an AC Output Power Cable.....	48
5.5 Connecting DC Input Power Cables.....	52
5.6 (Optional) Connecting Battery Cables.....	56

5.7 Connecting Signal Cables.....	58
5.7.1 Connecting RS485 Communications Cables (Inverter Cascading).....	63
5.7.2 Connecting RS485 Communications Cables (Power Meter).....	64
5.7.3 Connecting RS485 Communications Cables (EMMA).....	69
5.7.4 Connecting RS485 Communications Cables (SmartGuard).....	71
5.7.5 Connecting the Rapid Shutdown Signal Cable.....	73
5.7.6 Connecting the Grid Scheduling Signal Cable.....	75
5.7.7 Connecting NS Protection Signal Cables.....	78
5.7.8 Connecting the Battery Signal Cable.....	80
5.8 (Optional) Installing the Smart Dongle and Anti-theft Components.....	82
6 Check Before Power-On.....	85
7 Power-On and Commissioning.....	86
7.1 Powering On the Inverter.....	86
7.2 Commissioning the Inverter (Smart Dongle Networking).....	92
7.2.1 Deploying a New Plant.....	92
7.2.2 Setting Common Parameters.....	93
7.2.3 AFCI.....	94
7.2.4 IPS Test (Italy CEI0-21).....	95
7.2.5 Limit on Power Purchased from Grid.....	97
7.2.6 Setting the Energy Measurement Mode.....	98
7.2.7 (Optional) Three-Phase Imbalance Control.....	99
7.2.8 Resetting the Password for Logging In to the Local Commissioning Screen.....	100
7.2.8.1 Resetting the Password After Connecting to the Device WLAN.....	101
7.2.8.2 Resetting the Password After Obtaining the Verification Code and Connecting to the Device WLAN.....	102
7.3 Commissioning the Inverter (EMMA Networking & SmartGuard Networking).....	103
7.3.1 Deploying a New Plant.....	103
7.3.2 Setting Common Parameters.....	104
7.3.3 AFCI.....	105
7.3.4 IPS Test (Italy CEI0-21).....	106
7.3.5 DRM (Australia AS 4777).....	108
7.3.6 Limit on Power Purchased from Grid.....	110
7.3.7 Setting the Energy Measurement Mode.....	111
7.3.8 (Optional) Three-Phase Imbalance Control.....	112
7.3.9 Resetting the Password for Logging In to the Local Commissioning Screen.....	113
7.3.9.1 Resetting the Password After Connecting to the Device WLAN.....	113
7.3.9.2 Resetting the Password After Obtaining the Verification Code and Connecting to the Device WLAN.....	114
7.4 Viewing the Plant Creation Status.....	115
8 System Maintenance.....	117
8.1 Routine Maintenance.....	117
8.2 System Power-Off.....	119

8.3 Troubleshooting.....	119
8.4 Replacing an Inverter.....	119
8.5 Locating Insulation Resistance Faults.....	120
9 Technical Specifications.....	124
A Grid Codes.....	129
B Connecting to the Inverter on the App.....	132
C Connecting to the EMMA on the App.....	135
D Resetting the Login Password on the Hardware.....	138
E Rapid Shutdown.....	140
F Baud Rate Negotiation.....	141
G Contact Information.....	145
H Digital Power Customer Service.....	147
I Certificate Management and Maintenance.....	148
I.1 Initial Certificate Risk Disclaimer.....	148
I.2 Application Scenarios of Initial Certificates.....	149
J Acronyms and Abbreviations.....	150

1 Safety Information

Statement

Before transporting, storing, installing, operating, using, and/or maintaining the equipment, read this document, strictly follow the instructions provided herein, and follow all the safety instructions on the equipment and in this document. In this document, "equipment" refers to the products, software, components, spare parts, and/or services related to this document; "the Company" refers to the manufacturer (producer), seller, and/or service provider of the equipment; "you" refers to the entity that transports, stores, installs, operates, uses, and/or maintains the equipment.

The **Danger, Warning, Caution, and Notice** statements described in this document do not cover all the safety precautions. You also need to comply with relevant international, national, or regional standards and industry practices. **The Company shall not be liable for any consequences that may arise due to violations of safety requirements or safety standards concerning the design, production, and usage of the equipment.**

The equipment shall be used in an environment that meets the design specifications. Otherwise, the equipment may be faulty, malfunctioning, or damaged, which is not covered under the warranty. The Company shall not be liable for any property loss, personal injury, or even death caused thereby.

Comply with applicable laws, regulations, standards, and specifications during transportation, storage, installation, operation, use, and maintenance.

Do not perform reverse engineering, decompilation, disassembly, adaptation, implantation, or other derivative operations on the equipment software. Do not study the internal implementation logic of the equipment, obtain the source code of the equipment software, violate intellectual property rights, or disclose any of the performance test results of the equipment software.

The Company shall not be liable for any of the following circumstances or their consequences:

- The equipment is damaged due to force majeure such as earthquakes, floods, volcanic eruptions, debris flows, lightning strikes, fires, wars, armed conflicts, typhoons, hurricanes, tornadoes, and other extreme weather conditions.
- The equipment is operated beyond the conditions specified in this document.

- The equipment is installed or used in environments that do not comply with international, national, or regional standards.
- The equipment is installed or used by unqualified personnel.
- You fail to follow the operation instructions and safety precautions on the product and in the document.
- You remove or modify the product or modify the software code without authorization.
- You or a third party authorized by you cause the equipment damage during transportation.
- The equipment is damaged due to storage conditions that do not meet the requirements specified in the product document.
- You fail to prepare materials and tools that comply with local laws, regulations, and related standards.
- The equipment is damaged due to your or a third party's negligence, intentional breach, gross negligence, or improper operations, or other reasons not related to the Company.

1.1 Personal Safety

 **DANGER**

Ensure that power is off during installation. Do not install or remove a cable with power on. Transient contact between the core of the cable and the conductor will generate electric arcs or sparks, which may cause a fire or personal injury.

 **DANGER**

Non-standard and improper operations on the energized equipment may cause fire, electric shocks, or explosion, resulting in property damage, personal injury, or even death.

 **DANGER**

Before operations, remove conductive objects such as watches, bracelets, bangles, rings, and necklaces to prevent electric shocks.

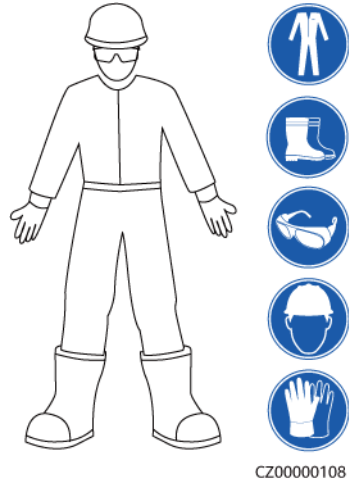
 **DANGER**

During operations, use dedicated insulated tools to prevent electric shocks or short circuits. The dielectric withstanding voltage level must comply with local laws, regulations, standards, and specifications.

WARNING

During operations, wear personal protective equipment such as protective clothing, insulated shoes, goggles, safety helmets, and insulated gloves.

Figure 1-1 Personal protective equipment



General Requirements

- Do not stop protective devices. Pay attention to the warnings, cautions, and related precautionary measures in this document and on the equipment.
- If there is a likelihood of personal injury or equipment damage during operations, immediately stop, report the case to the supervisor, and take feasible protective measures.
- Do not power on the equipment before it is installed or confirmed by professionals.
- Do not touch the power supply equipment directly or with conductors such as damp objects. Before touching any conductor surface or terminal, measure the voltage at the contact point to ensure that there is no risk of electric shock.
- Do not touch operating equipment because the enclosure is hot.
- Do not touch a running fan with your hands, components, screws, tools, or boards. Otherwise, personal injury or equipment damage may occur.
- In the case of a fire, immediately leave the building or the equipment area and activate the fire alarm or call emergency services. Do not enter the affected building or equipment area under any circumstances.

Personnel Requirements

- Only professionals and trained personnel are allowed to operate the equipment.
 - Professionals: personnel who are familiar with the working principles and structure of the equipment, trained or experienced in equipment operations and are clear of the sources and degree of various potential hazards in equipment installation, operation, maintenance

- Trained personnel: personnel who are trained in technology and safety, have required experience, are aware of possible hazards on themselves in certain operations, and are able to take protective measures to minimize the hazards on themselves and other people
- Personnel who plan to install or maintain the equipment must receive adequate training, be able to correctly perform all operations, and understand all necessary safety precautions and local relevant standards.
- Only qualified professionals or trained personnel are allowed to install, operate, and maintain the equipment.
- Only qualified professionals are allowed to remove safety facilities and inspect the equipment.
- Personnel who will perform special tasks such as electrical operations, working at heights, and operations of special equipment must possess the required local qualifications.
- Only authorized professionals are allowed to replace the equipment or components (including software).
- Only personnel who need to work on the equipment are allowed to access the equipment.

1.2 Electrical Safety

 **DANGER**

Before connecting cables, ensure that the equipment is intact. Otherwise, electric shocks or fire may occur.

 **DANGER**

Non-standard and improper operations may result in fire or electric shocks.

 **DANGER**

Prevent foreign matter from entering the equipment during operations. Otherwise, equipment short-circuits or damage, load power derating, power failure, or personal injury may occur.

 **WARNING**

For the equipment that needs to be grounded, install the ground cable first when installing the equipment and remove the ground cable last when removing the equipment.

 **WARNING**

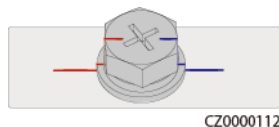
During the installation of PV strings and the inverter, the positive or negative terminals of PV strings may be short-circuited to ground if the power cables are not properly installed or routed. In this case, an AC or DC short circuit may occur and damage the inverter. The resulting device damage is not covered under any warranty.

 **CAUTION**

Do not route cables near the air intake or exhaust vents of the equipment.

General Requirements

- Follow the procedures described in the document for installation, operation, and maintenance. Do not reconstruct or alter the equipment, add components, or change the installation sequence without permission.
- Obtain approval from the national or local electric utility company before connecting the equipment to the grid.
- Observe the power plant safety regulations, such as the operation and work ticket mechanisms.
- Install temporary fences or warning ropes and hang "No Entry" signs around the operation area to keep unauthorized personnel away from the area.
- Before installing or removing power cables, turn off the switches of the equipment and its upstream and downstream switches.
- Before performing operations on the equipment, check that all tools meet the requirements and record the tools. After the operations are complete, collect all of the tools to prevent them from being left inside the equipment.
- Before installing power cables, check that cable labels are correct and cable terminals are insulated.
- When installing the equipment, use a torque tool of a proper measurement range to tighten the screws. When using a wrench to tighten the screws, ensure that the wrench does not tilt and the torque error does not exceed 10% of the specified value.
- Ensure that bolts are tightened with a torque tool and marked in red and blue after double-check. Installation personnel mark tightened bolts in blue. Quality inspection personnel confirm that the bolts are tightened and then mark them in red. (The marks must cross the edges of the bolts.)



- If the equipment has multiple inputs, disconnect all the inputs and wait until the equipment is completely powered off before performing operations on the equipment.
- Before maintaining a downstream electrical or power distribution device, turn off the output switch on the power supply equipment.

- During equipment maintenance, attach "Do not switch on" labels near the upstream and downstream switches or circuit breakers as well as warning signs to prevent accidental connection. The equipment can be powered on only after troubleshooting is complete.
- Do not open equipment panels.
- Check equipment connections periodically, ensuring that all screws are securely tightened.
- Only qualified professionals can replace a damaged cable.
- Do not scrawl, damage, or block any labels or nameplates on the equipment. Promptly replace labels that have worn out.
- Do not use solvents such as water, alcohol, or oil to clean electrical components inside or outside of the equipment.

Grounding

- Ensure that the grounding impedance of the equipment complies with local electrical standards.
- Ensure that the equipment is connected permanently to the protective ground. Before operating the equipment, check its electrical connection to ensure that it is reliably grounded.
- Do not work on the equipment in the absence of a properly installed ground conductor.
- Do not damage the ground conductor.

Cabling Requirements

- When selecting, installing, and routing cables, follow local safety regulations and rules.
- When routing power cables, ensure that there is no coiling or twisting. Do not join or weld power cables. If necessary, use a longer cable.
- Ensure that all cables are properly connected and insulated, and meet specifications.
- Ensure that the slots and holes for routing cables are free from sharp edges, and that the positions where cables are routed through pipes or cable holes are equipped with cushion materials to prevent the cables from being damaged by sharp edges or burrs.
- Ensure that cables of the same type are bound together neatly and straight and that the cable sheath is intact. When routing cables of different types, ensure that they are away from each other without entanglement and overlapping.
- Secure buried cables using cable supports and cable clips. Ensure that the cables in the backfill area are in close contact with the ground to prevent cable deformation or damage during backfilling.
- If the external conditions (such as the cable layout or ambient temperature) change, verify the cable usage in accordance with the IEC-60364-5-52 or local laws and regulations. For example, check that the current-carrying capacity meets requirements.
- When routing cables, reserve at least 30 mm clearance between the cables and heat-generating components or areas. This prevents deterioration or damage to the cable insulation layer.

1.3 Environment Requirements

 **DANGER**

Do not expose the equipment to flammable or explosive gas or smoke. Do not perform any operation on the equipment in such environments.

 **DANGER**

Do not store any flammable or explosive materials in the equipment area.

 **DANGER**

Do not place the equipment near heat sources or fire sources, such as smoke, candles, heaters, or other heating devices. Overheat may damage the equipment or cause a fire.

 **WARNING**

Install the equipment in an area far away from liquids. Do not install it under areas prone to condensation, such as under water pipes and air exhaust vents, or areas prone to water leakage, such as air conditioner vents, ventilation vents, or feeder windows of the equipment room. Ensure that no liquid enters the equipment to prevent faults or short circuits.

 **WARNING**

To prevent damage or fire due to high temperature, ensure that the ventilation vents or heat dissipation systems are not obstructed or covered by other objects while the equipment is running.

General Requirements

- Store the equipment according to the storage requirements. Equipment damage caused by unqualified storage conditions is not covered under the warranty.
- Keep the installation and operating environments of the equipment within the allowed ranges. Otherwise, its performance and safety will be compromised.
- The operating temperature range provided in the equipment's technical specifications refers to the ambient temperatures in equipment's installation environment.

- Do not install, use, or operate outdoor equipment and cables (including but not limited to moving equipment, operating equipment and cables, inserting connectors to or removing connectors from signal ports connected to outdoor facilities, working at heights, performing outdoor installation, and opening doors) in harsh weather conditions such as lightning, rain, snow, and level 6 or stronger wind.
- Do not install the equipment in an environment with dust, smoke, volatile or corrosive gases, infrared and other radiations, organic solvents, or salty air.
- Do not install the equipment in an environment with conductive metal or magnetic dust.
- Do not install the equipment in an area conducive to the growth of microorganisms such as fungus or mildew.
- Do not install the equipment in an area with strong vibration, noise, or electromagnetic interference.
- Ensure that the site complies with local laws, regulations, and related standards.
- Ensure that the ground in the installation environment is solid, free from spongy or soft soil, and not prone to subsidence. The site must not be located in a low-lying land prone to water or snow accumulation, and the horizontal level of the site must be above the highest water level of that area in history.
- Do not install the equipment in a position that may be submerged in water.
- If the equipment is installed in a place with abundant vegetation, in addition to routine weeding, harden the ground underneath the equipment using cement or gravel (the area shall be greater than or equal to 3 m x 2.5 m).
- Do not install the equipment outdoors in salt-affected areas because it may be corroded. A salt-affected area refers to the region within 500 m of the coast or prone to sea breeze. Regions prone to sea breeze vary with weather conditions (such as typhoons and monsoons) or terrains (such as dams and hills).
- Before installation, operation, and maintenance, clean up any water, ice, snow, or other foreign objects on the top of the equipment.
- When installing the equipment, ensure that the installation surface is solid enough to bear the weight of the equipment.
- After installing the equipment, remove the packing materials such as cartons, foam, plastics, and cable ties from the equipment area.

1.4 Mechanical Safety

 **WARNING**

Ensure that all necessary tools are ready and inspected by a professional organization. Do not use tools that have signs of scratches or fail to pass the inspection or whose inspection validity period has expired. Ensure that the tools are secure and not overloaded.

 **WARNING**

Do not drill holes into the equipment. Doing so may affect the sealing performance and electromagnetic containment of the equipment and damage components or cables inside. Metal shavings from drilling may short-circuit boards inside the equipment.

General Requirements

- Repaint any paint scratches caused during equipment transportation or installation in a timely manner. Equipment with scratches must not be exposed for an extended period of time.
- Do not perform operations such as arc welding and cutting on the equipment without evaluation by the Company.
- Do not install other devices on the top of the equipment without evaluation by the Company.
- When performing operations over the top of the equipment, take measures to protect the equipment against damage.
- Use correct tools and operate them in the correct way.

Moving Heavy Objects

- Be cautious to prevent injury when moving heavy objects.



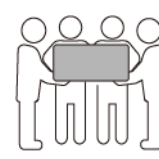
< 18 kg
(< 40 lbs)



18–32 kg
(40–70 lbs)



32–55 kg
(70–121 lbs)



55–68 kg
(121–150 lbs)



> 68 kg
(> 150 lbs)

CZ0000110

- If multiple persons need to move a heavy object together, determine the manpower and work division with consideration of height and other conditions to ensure that the weight is equally distributed.
- If two persons or more move a heavy object together, ensure that the object is lifted and landed simultaneously and moved at a uniform pace under the supervision of one person.
- Wear personal protective gears such as protective gloves and shoes when manually moving the equipment.
- To move an object by hand, approach to the object, squat down, and then lift the object gently and stably by the force of the legs instead of your back. Do not lift it suddenly or turn your body around.
- Do not quickly lift a heavy object above your waist. Place the object on a workbench that is half-waist high or any other appropriate place, adjust the positions of your palms, and then lift it.
- Move a heavy object stably with balanced force at an even and low speed. Put down the object stably and slowly to prevent any collision or drop from scratching the surface of the equipment or damaging the components and cables.

- When moving a heavy object, be aware of the workbench, slope, staircase, and slippery places. When moving a heavy object through a door, ensure that the door is wide enough to move the object and avoid bumping or injury.
- When transferring a heavy object, move your feet instead of turning your waist around. When lifting and transferring a heavy object, ensure that your feet point to the target direction of movement.
- When transporting the equipment using a pallet truck or forklift, ensure that the tynes are properly positioned so that the equipment does not topple. Before moving the equipment, secure it to the pallet truck or forklift using ropes. When moving the equipment, assign dedicated personnel to take care of it.
- Choose sea, roads in good conditions, or airplanes for transportation. Do not transport the equipment by railway. Avoid tilt or jolt during transportation.

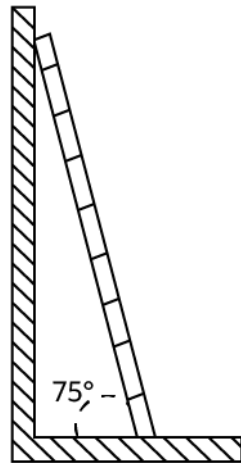
Using Ladders

- Use wooden or insulated ladders when you need to perform live-line working at heights.
- Platform ladders with protective rails are preferred. Single ladders are not recommended.
- Before using a ladder, check that it is intact and confirm its load bearing capacity. Do not overload it.
- Ensure that the ladder is securely positioned and held firm.



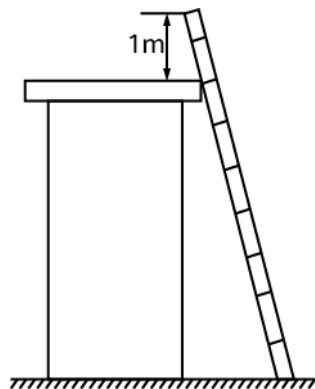
CZ00000107

- When climbing up the ladder, keep your body stable and your center of gravity between the side rails, and do not overreach to the sides.
- When a step ladder is used, ensure that the pull ropes are secured.
- If a single ladder is used, the recommended angle for the ladder against the floor is 75 degrees, as shown in the following figure. A square can be used to measure the angle.



PI02SC0008

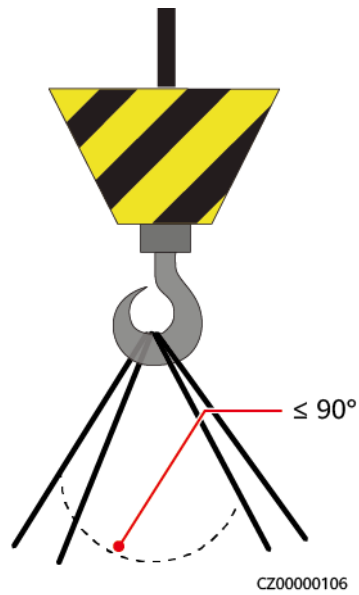
- If a single ladder is used, ensure that the wider end of the ladder is at the bottom, and take protective measures to prevent the ladder from sliding.
- If a single ladder is used, do not climb higher than the fourth rung of the ladder from the top.
- If you use a single ladder to climb up to a platform, ensure that the ladder is at least 1 m higher than the platform.



PI02SC0009

Hoisting

- Only trained and qualified personnel are allowed to perform hoisting operations.
- Install temporary warning signs or fences to isolate the hoisting area.
- Ensure that the foundation where hoisting is performed on meets the load-bearing requirements.
- Before hoisting objects, ensure that hoisting tools are firmly secured onto a fixed object or wall that meets the load-bearing requirements.
- During hoisting, do not stand or walk under the crane or the hoisted objects.
- Do not drag steel ropes and hoisting tools or bump the hoisted objects against hard objects during hoisting.
- Ensure that the angle between two hoisting ropes is no more than 90 degrees, as shown in the following figure.



Drilling Holes

- Obtain consent from the customer and contractor before drilling holes.
- Wear protective equipment such as safety goggles and protective gloves when drilling holes.
- To avoid short circuits or other risks, do not drill holes into buried pipes or cables.
- When drilling holes, protect the equipment from shavings. After drilling, clean up any shavings.

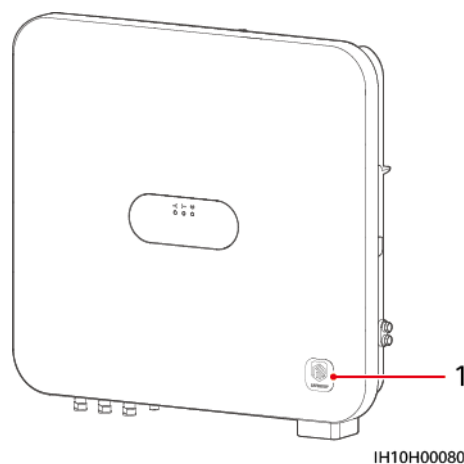
2 Overview

The SUN5000 is a three-phase grid-tied PV string inverter that converts the DC power generated by PV strings into AC power and feeds the power into the power grid.

NOTICE

Optimizers must be configured for all PV modules connected to the SUN5000 inverter. Otherwise, the inverter cannot be started.

Figure 2-1 SUN5000



(1) Safety sign

2.1 Model Number Description

This document involves the following product models:

- SUN5000-8K-MAP0
- SUN5000-12K-MAP0

Figure 2-2 Model number (using SUN5000-12K-MAP0 as an example)

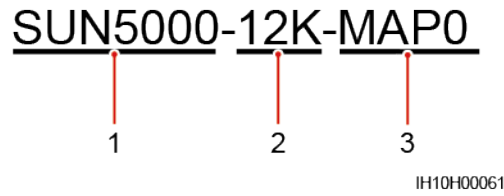


Table 2-1 Model number description

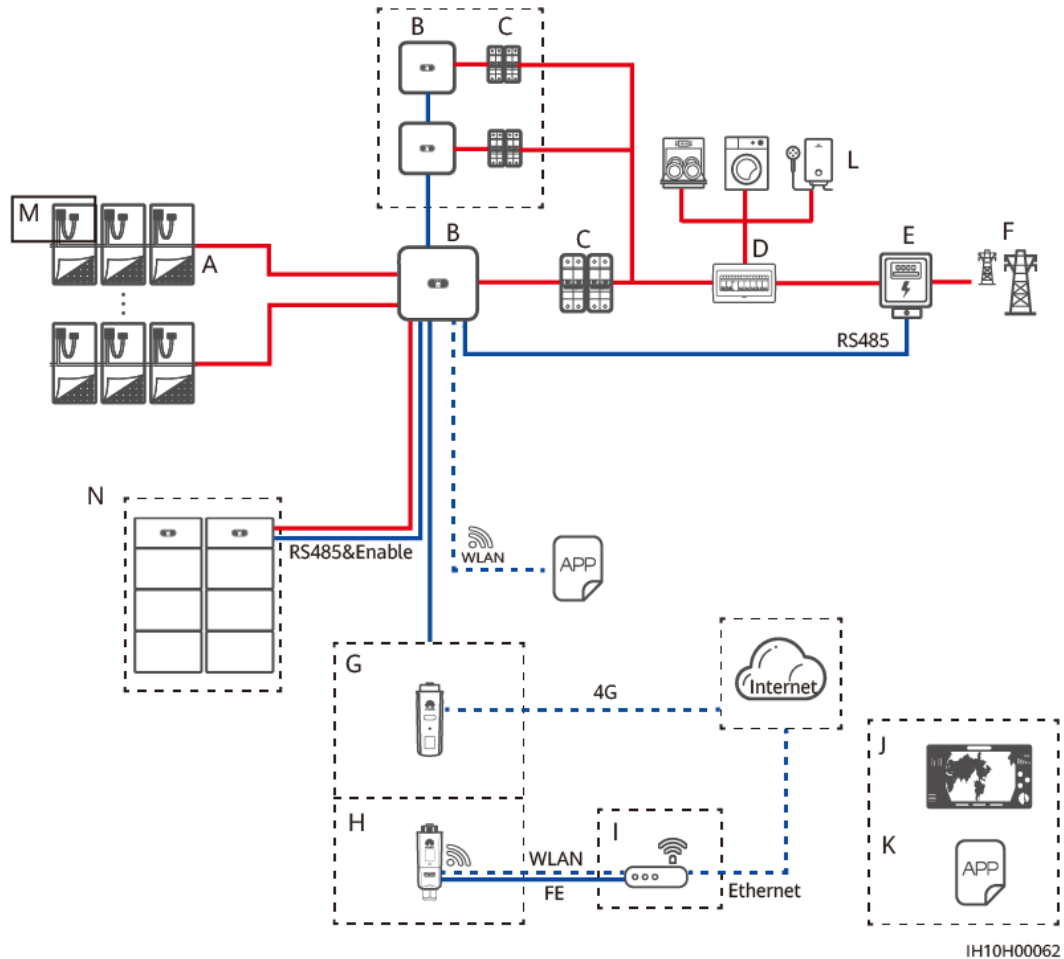
No.	Item	Description
1	Series name	SUN5000: three-phase grid-tied PV string inverter
2	Power	<ul style="list-style-type: none"> ● 8K: The rated power is 8 kW. ● 12K: The rated power is 12 kW.
3	Design code	MAP0: three-phase product series with the DC input voltage level of 1000 V or 1100 V

2.2 Networking Application

The SUN5000 applies to grid-tied PV systems for residential rooftop projects and small-sized ground-mounted plants. The system consists of PV strings, grid-tied inverters, AC switches, and power distribution units (PDUs).

Smart Dongle Networking

Figure 2-3 Smart Dongle networking (dashed boxes indicate optional components)



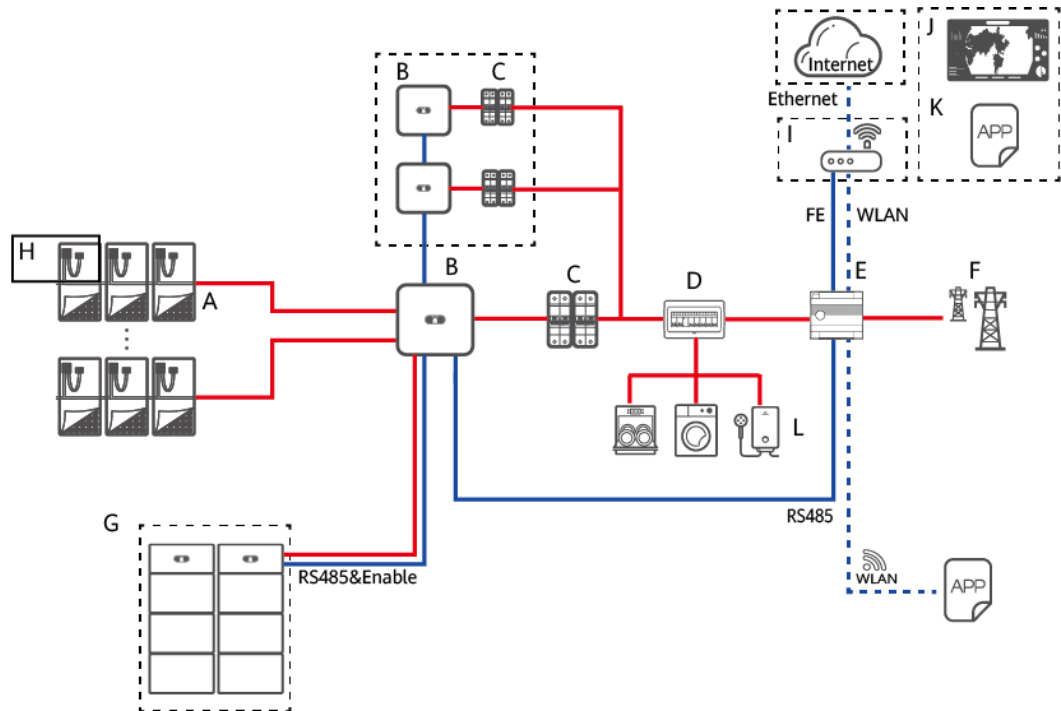
- | | | |
|--|--------------------------|-----------------|
| (A) PV string | (B) SUN5000 | (C) AC switches |
| (D) AC PDU | (E) Power meter | (F) Power grid |
| (G) 4G Smart Dongle | (H) WLAN-FE Smart Dongle | (I) Router |
| (J) FusionSolar Smart PV Management System (SmartPVMS) | (K) FusionSolar app | (L) Load |
| (M) Smart PV Optimizer | (N) Battery | |

NOTE

For details about the Smart Dongle networking, see the [Residential Smart PV Solution Quick Guide \(Three-Phase PV+ESS Scenario + Smart Dongle Networking\)](#).

EMMA Networking

Figure 2-4 EMMA networking (dashed boxes indicate optional components)



IH10H00063

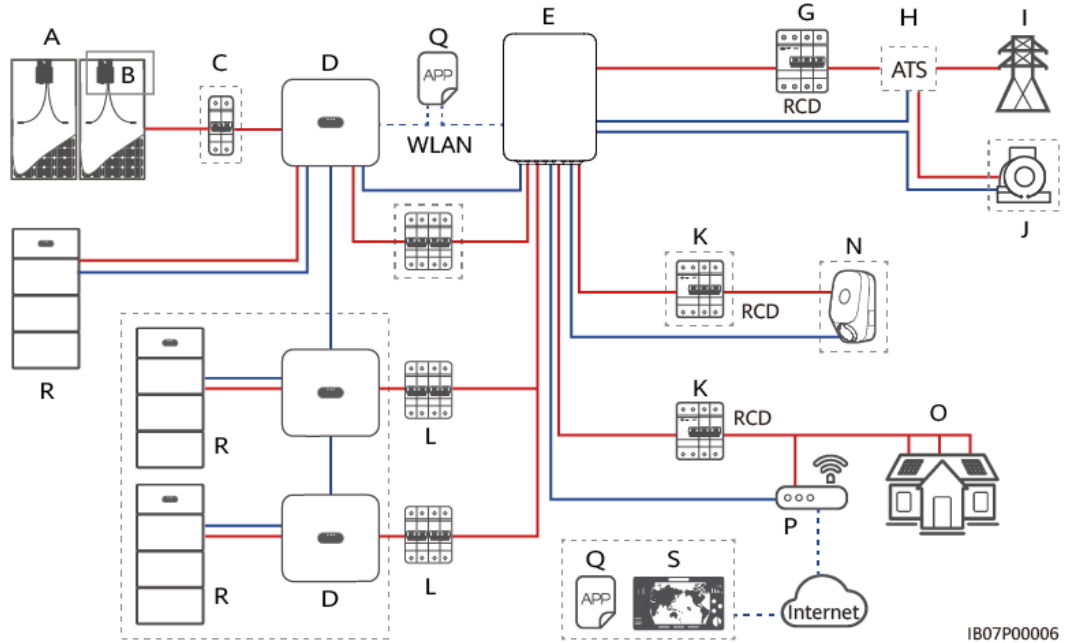
- | | | |
|--|------------------------|-----------------|
| (A) PV string | (B) SUN5000 | (C) AC switches |
| (D) AC PDU | (E) EMMA | (F) Power grid |
| (G) Battery | (H) Smart PV Optimizer | (I) Router |
| (J) FusionSolar Smart PV Management System (SmartPVMS) | (K) FusionSolar app | (L) Load |

NOTE

For details about EMMA networking, see [Residential Smart PV Solution Quick Guide \(Three-Phase PV+ESS Scenario + EMMA Networking\)](#) or [Residential Smart PV Solution User Manual \(EMMA\)](#).

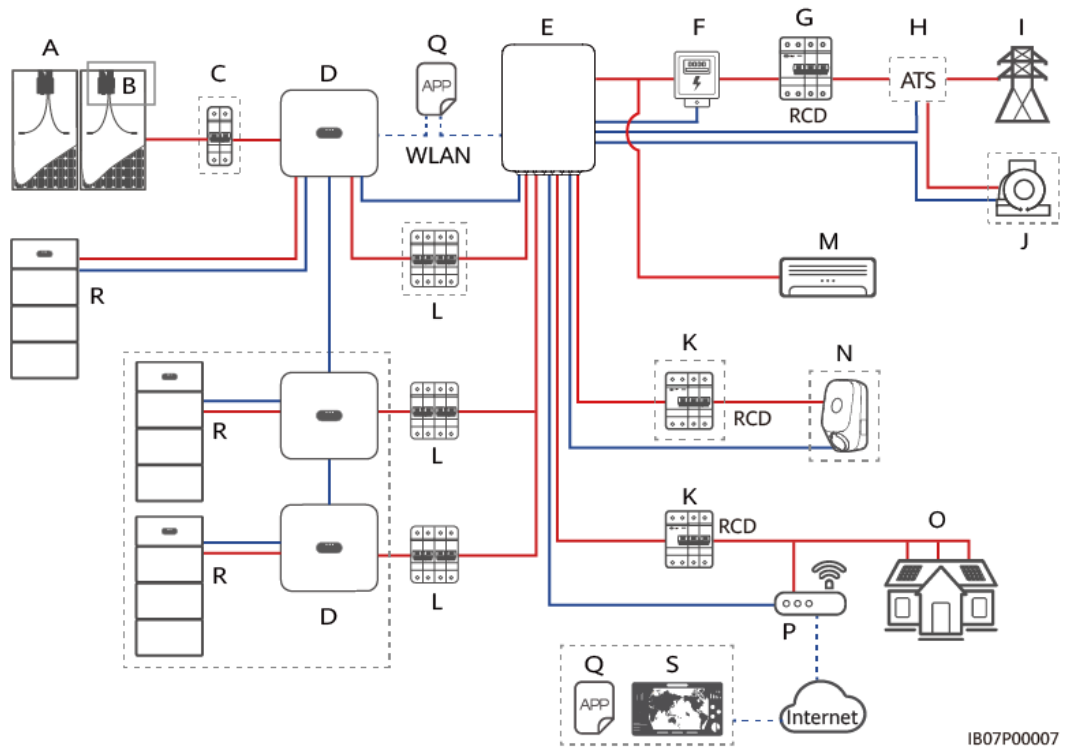
SmartGuard Networking

Figure 2-5 Networking with all loads connected to the SmartGuard (dashed boxes indicate optional components)



IB07P00006

Figure 2-6 Networking with some of loads connected to the SmartGuard (dashed boxes indicate optional components)



IB07P00007

(A) PV string	(B) Smart PV Optimizer	(C) DC switch
(D) SUN5000	(E) SmartGuard	(F) Power meter
(G) Main circuit breaker	(H) ATS	(I) Power grid
(J) Genset	(K) Residual current device (RCD)	(L) AC switches
(M) Load not connected to the SmartGuard	(N) Non-backup load	(O) Backup load
(P) Router	(Q) FusionSolar app	(R) LUNA2000

 **NOTE**

For details about the SmartGuard networking scenario, see the [Residential Smart PV Solution Quick Guide \(Three-Phase PV+ESS Scenario + SmartGuard Networking\)](#).

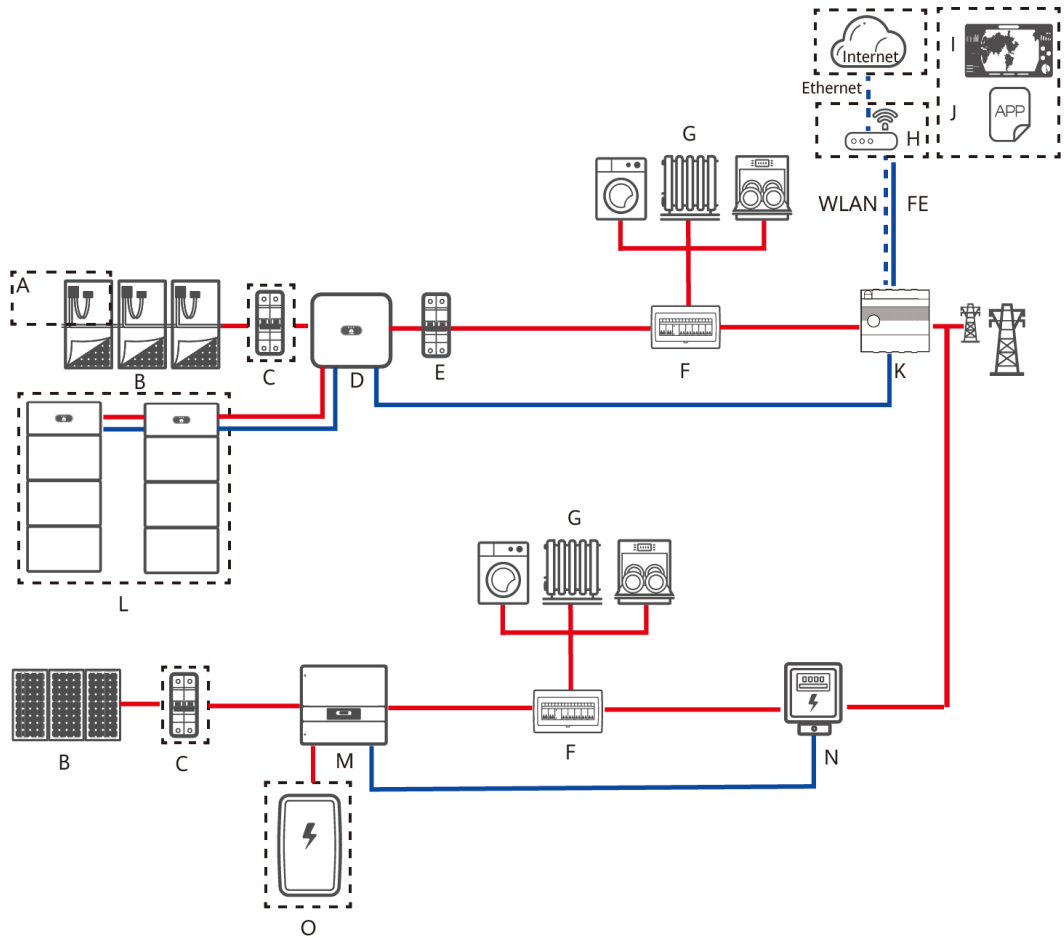
 **NOTE**

- The voltage of different MPPT circuits must be the same.
- The MPPT voltage must be greater than the lower threshold of the full-load MPPT range specified in the inverter technical data sheet. Otherwise, the inverter will be derated, causing the system yield loss.

Compatibility with Third-Party Systems

Huawei inverters are compatible with third-party inverters or third-party energy storage systems (ESSs).

Figure 2-7 Networking with third-party systems

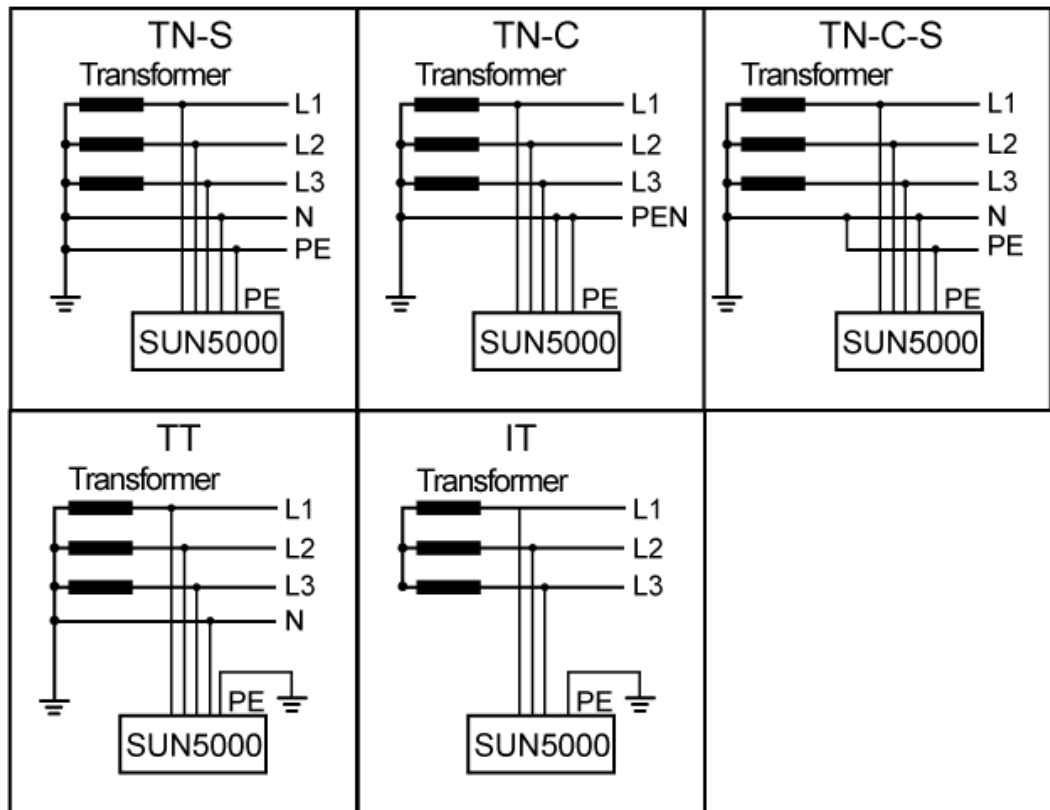


- | | | |
|---|-----------------|--|
| (A) Optimizer | (B) PV string | (C) DC switch |
| (D) Huawei smart PV inverter | (E) AC switch | (F) AC power distribution unit (PDU) |
| (G) Load | (H) Router | (I) FusionSolar Smart PV Management System (SmartPVMS) |
| (J) FusionSolar app | (K) EMMA | (L) LUNA2000 |
| (M/O) Third-party inverter or third-party ESS | (N) Power meter | |

Earthing Systems

The inverter supports the TN-S, TN-C, TN-C-S, TT, and IT earthing systems.

Figure 2-8 Earthing systems



IH10H00070

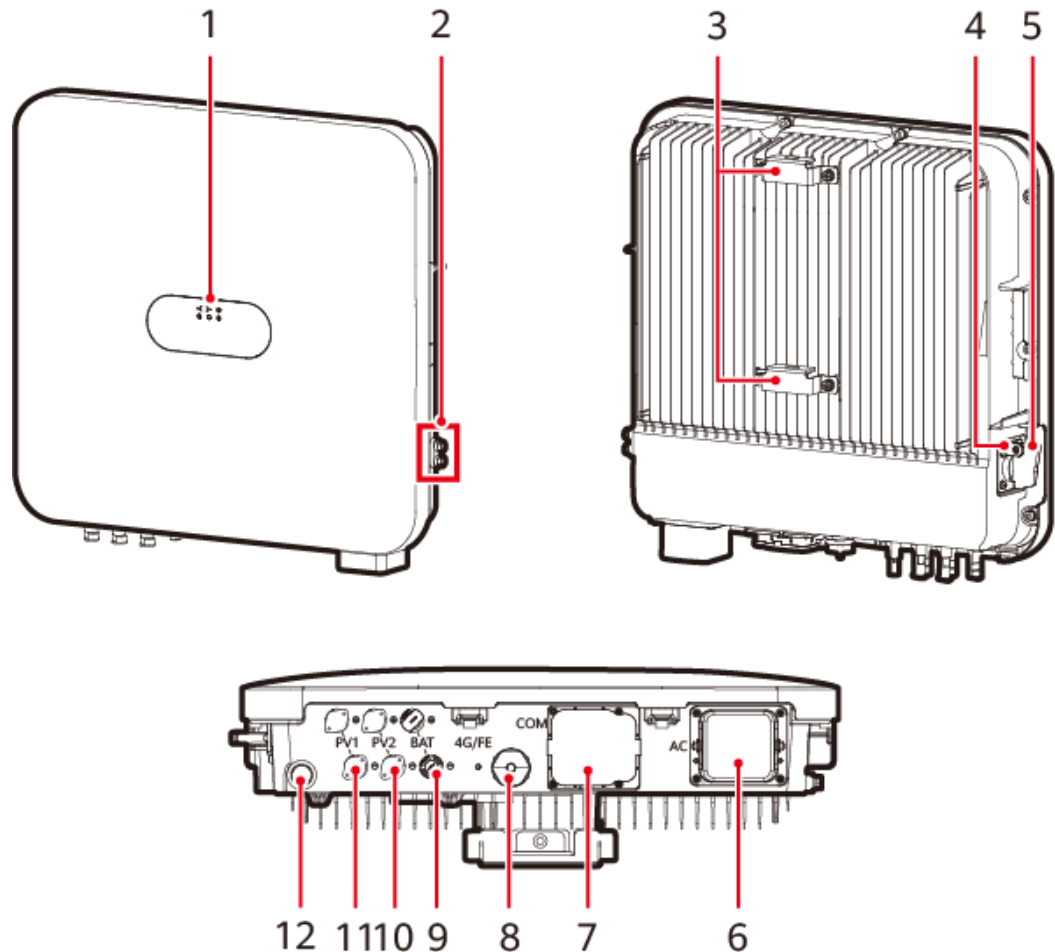
NOTE

- In a TT power grid, the N-PE voltage should be lower than 30 V.
- In an IT power grid, you need to set **isolation settings** to **input not grounded, with a transformer**.

2.3 Appearance

Appearance and Ports

Figure 2-9 Appearance



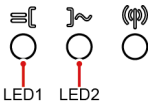
IH10H00010

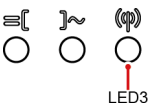
- | | |
|---|---|
| (1) LED indicators | (2) Ground screws |
| (3) Mounting bracket | (4) Hole for the DC switch padlock ^[1] |
| (5) DC switch (DC SWITCH) | (6) AC output port (AC) |
| (7) Communications port (COM) | (8) Smart Dongle port (4G/FE) |
| (9) Battery terminals (BAT1+ and BAT1-) | (10) DC input terminals (PV2+ and PV2-) |
| (11) DC input terminals (PV1+ and PV1-) | (12) Ventilation valve |

Note [1]: For models used in Australia, the DC switch padlock needs to be installed according to the local standard to secure the DC switch (DC SWITCH) and prevent incorrect startup. The DC switch padlock needs to be prepared by the customer.

Indicator Description

Table 2-2 LED indicator description

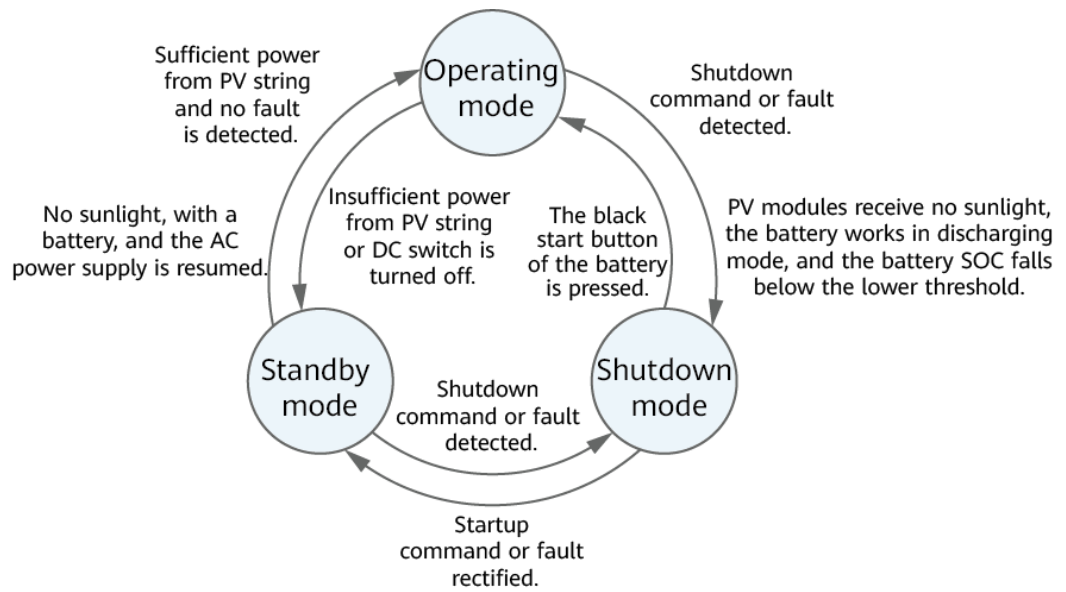
Category	Status		Description
Running indication 	LED1	LED2	-
	Steady green	Steady green	The inverter is operating in grid-tied mode.
	Blinking green slowly (on for 1s and off for 1s)	Off	The DC is on and the AC is off.
	Blinking green slowly (on for 1s and off for 1s)	Blinking green slowly (on for 1s and off for 1s)	Both the DC and AC are on, and the inverter is off-grid.
	Off	Blinking green slowly (on for 1s and off for 1s)	The DC is off and the AC is on.
	Steady yellow	Steady yellow	The inverter is running in off-grid state.
	Blinking yellow slowly	Off	The DC is on and the inverter has no output in off-grid state.
	Blinking yellow slowly	Blinking yellow slowly	The inverter is overloaded in off-grid state.
	Off	Off	Both the DC and AC are off.
	Blinking red fast (on for 0.2s and off for 0.2s)	-	There is a DC environmental alarm, such as High String Input Voltage , String Reverse Connection , or Low Insulation Resistance .

Category	Status			Description
	-	Blinking red fast		There is an AC environmental alarm, such as Grid Undervoltage, Grid Overvoltage, Grid Overfrequency, or Grid Underfrequency.
	Steady red	Steady red		A fault exists.
Communica tion indication 	LED3			-
	Blinking green fast (on for 0.2s and off for 0.2s)			Communication is in progress. (When a mobile phone is connected to the inverter, the indicator first blinks green slowly, indicating that the phone is connected to the inverter.)
	Blinking green slowly (on for 1s and off for 1s)			The mobile phone is connected to the inverter.
	Off			There is no communication.
Device replacement indication	LED1	LED2	LED3	-
	Steady red	Steady red	Steady red	The inverter hardware is faulty and needs to be replaced.

2.4 Working Modes

The inverter has three working modes: standby, operating, and shutdown.

Figure 2-10 Working modes



IS07500002






Table 2-3 Working mode description




Working Mode	Description
Standby	The inverter enters standby mode when the external environment does not meet the operating requirements. In standby mode: <ul style="list-style-type: none"> • The inverter continuously detects its operation status. Once the operation conditions are met, the inverter enters operating mode. • If the inverter receives a shutdown command or detects a fault after startup, it enters shutdown mode.
Operating	In operating mode: <ul style="list-style-type: none"> • The inverter converts DC power from PV strings into AC power and feeds the power to the power grid. • The inverter tracks the maximum power point to maximize the PV string output power. • If the inverter receives a shutdown command or detects a fault, it enters shutdown mode. • If the inverter detects that the output power of PV strings does not meet the requirements for grid-tied power generation and no battery is used in the system, it enters standby mode. • If the PV modules receive no sunlight, the inverter enters shutdown mode after the batteries discharge to the lower SOC threshold.

Working Mode	Description
Shutdown	<ul style="list-style-type: none"> • In standby or operating mode, if the inverter receives a shutdown command or detects a fault, it enters shutdown mode. • In shutdown mode, if the inverter detects that the fault is rectified or receives a startup command, it enters standby mode. • In shutdown mode, if the black start button of the battery is pressed, the inverter enters operating mode.

2.5 Label Description

Enclosure Labels

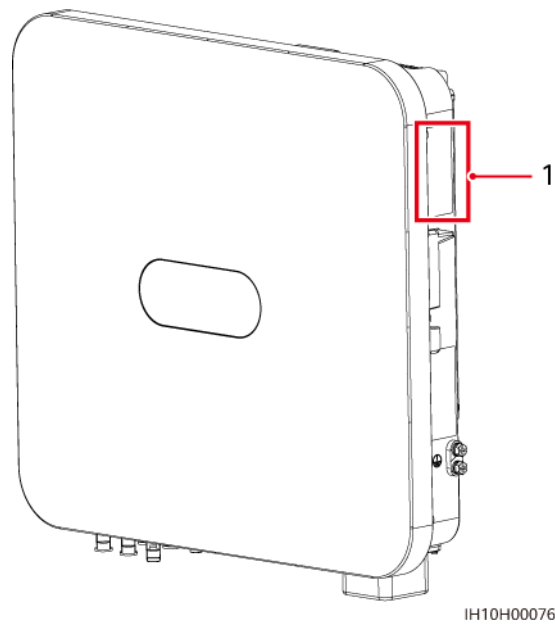
Label	Symbol	Name	Meaning
		Delayed discharge	Residual voltage exists after the inverter is powered off. It takes 5 minutes for the inverter to discharge to the safe voltage level before maintenance.
		Operation warning	Do not remove the DC input connector or AC output connector when the inverter is running.
		Burn warning	Do not touch the inverter when it is running because its enclosure is hot.
		Refer to documentation	Reminds operators to refer to the documents delivered with the inverter.

Label	Symbol	Name	Meaning
		Electric shock warning	<ul style="list-style-type: none"> High voltage exists after the inverter is powered on. Only qualified and trained electrical technicians are allowed to perform operations on the inverter. High touch current exists after the inverter is powered on. Before powering on the inverter, ensure that the inverter is properly grounded.
 (1P)PN/ITEM:XXXXXXXX Y (32P)Model: XXXXXXXX (S)SN:XXXXXXXXXXXXX MADE IN CHINA	-	Serial number (SN)	Indicates the product SN.
REGKEY SN:XXXXXXXXXXXXXXXXXXXXX REGKEY:XX WIFI SSID:XXXXXXXXXXXXXXXXXXXXX PSW:XXXXXXXXX 	-	QR code for inverter WiFi connection	Scan the QR code to connect to the Huawei inverter WiFi.

Product Nameplate

The nameplate contains the trademark, product model, important technical specifications, compliance symbols, company name, and place of origin.

Figure 2-11 Position of the nameplate



(1) Position of the nameplate

3 Storage Requirements

The following requirements shall be met if inverters are not put into use immediately:

- Do not unpack inverters.
- Keep the storage temperature at -40°C to $+70^{\circ}\text{C}$ and the humidity at 5%–95% RH.
- Store inverters in a clean and dry place and protect them from dust and moisture.
- Inverters can be stacked in a maximum of eight layers. To avoid personal injury or device damage, stack inverters with caution to prevent them from falling over.
- During the storage period, check inverters periodically (recommended: once every three months). Replace the packing materials that are damaged by insects or rodents in a timely manner.
- If inverters have been stored for two years or longer, they must be checked and tested by professionals before being put into use.

4 Installation

4.1 Installation Modes

The inverter can be wall-mounted or support-mounted.

Table 4-1 Installation modes

Installation Mode	Screw Specifications	Description
Wall mounting	M6x50 stainless steel expansion bolt	Delivered with the product
Support mounting	M6 stainless steel bolt assembly	Prepared by the customer

4.2 Installation Requirements

4.2.1 Site Selection Requirements

Basic Requirements

- The inverter is protected to IP66 and can be installed indoors or outdoors.
- Do not install the inverter in a place where personnel are easy to come into contact with its enclosure and heat sink, because these parts are hot during operation.
- Do not install the inverter in noise-sensitive areas.
- Do not install the inverter near flammable or explosive materials.
- Keep the inverter out of reach of children.
- Do not install the inverter outdoors in salt-affected areas because it will be corroded there and may cause fire. A salt-affected area refers to a region within 500 m of the coast or prone to sea breeze. Regions prone to sea breeze

vary with weather conditions (such as typhoons and monsoons) or terrains (such as dams and hills).

- Install the inverter in a well-ventilated environment to ensure good heat dissipation.
- You are advised to install the inverter in a sheltered area or install an awning over it.

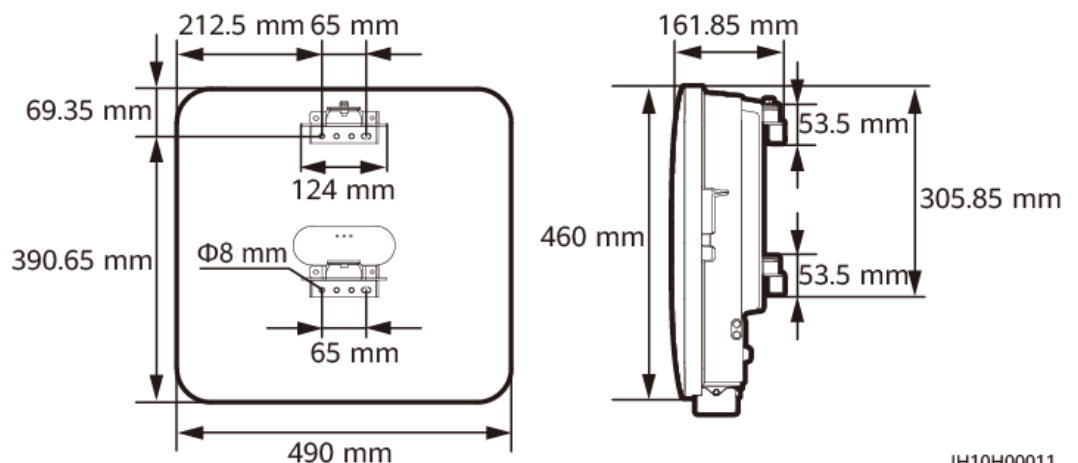
Mounting Structure Requirements

- The mounting structure where the device is installed must be fire resistant.
- Do not install the inverter on flammable building materials.
- The inverter is heavy. Ensure that the installation surface is solid enough to bear the inverter weight.
- In residential areas, do not install the inverter on a drywall or wall made of similar materials which have a weak sound insulation performance because the inverter generates noise during operation.

4.2.2 Clearance Requirements

- Dimensions of the inverter and mounting holes

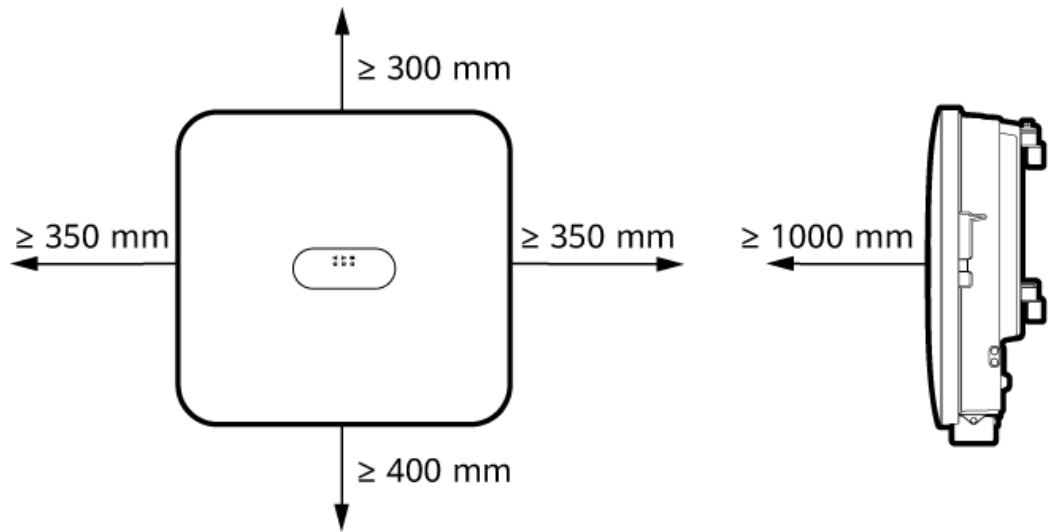
Figure 4-1 Dimensions of the inverter and mounting brackets



IH10H00011

- Reserve enough clearances around the inverter to ensure sufficient space for installation and heat dissipation.

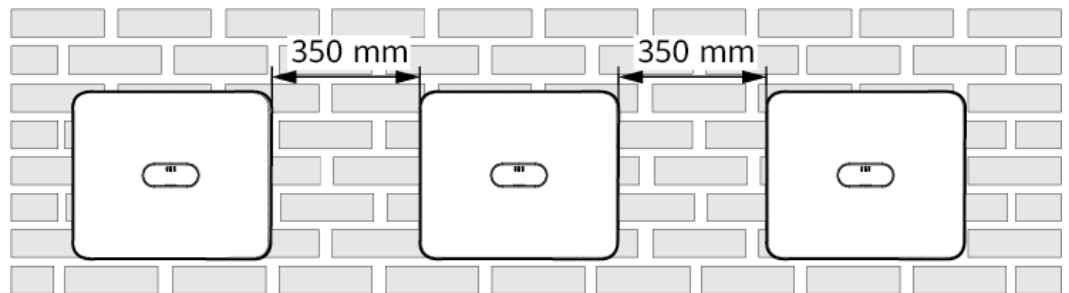
Figure 4-2 Clearances



IH10H00012

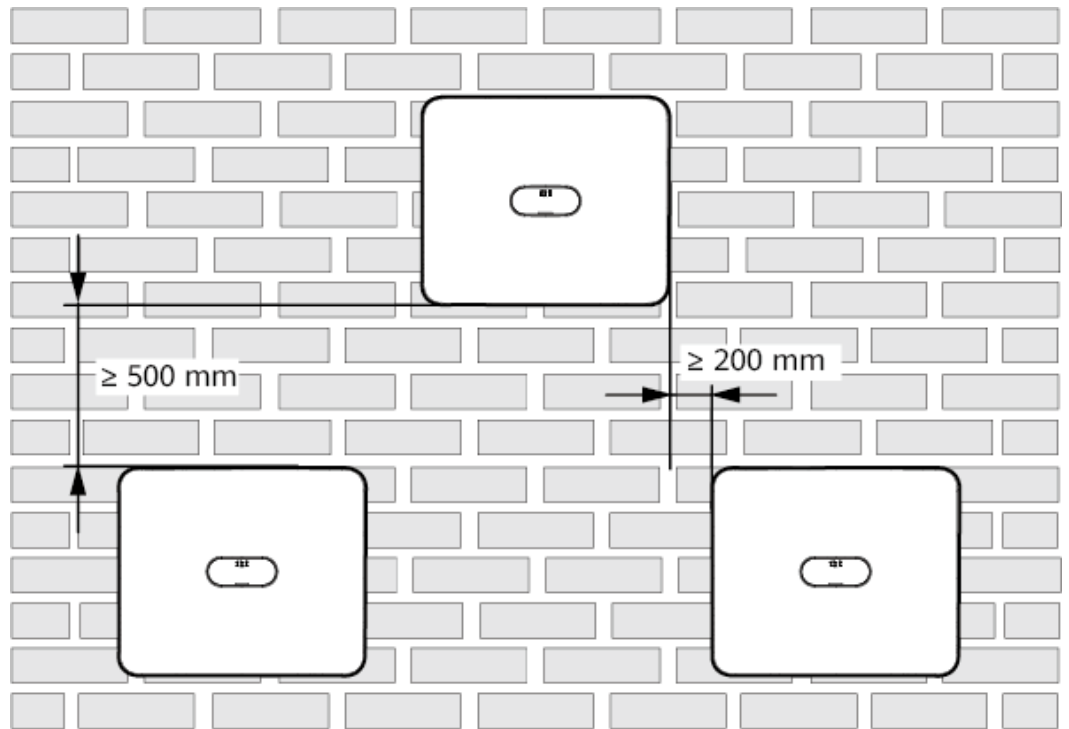
- When installing multiple inverters, install them in horizontal mode if sufficient space is available and install them in triangle mode if no sufficient space is available. Stacked installation is not recommended.

Figure 4-3 Horizontal installation mode (recommended)



IH08W00004

Figure 4-4 Triangle installation mode (recommended)



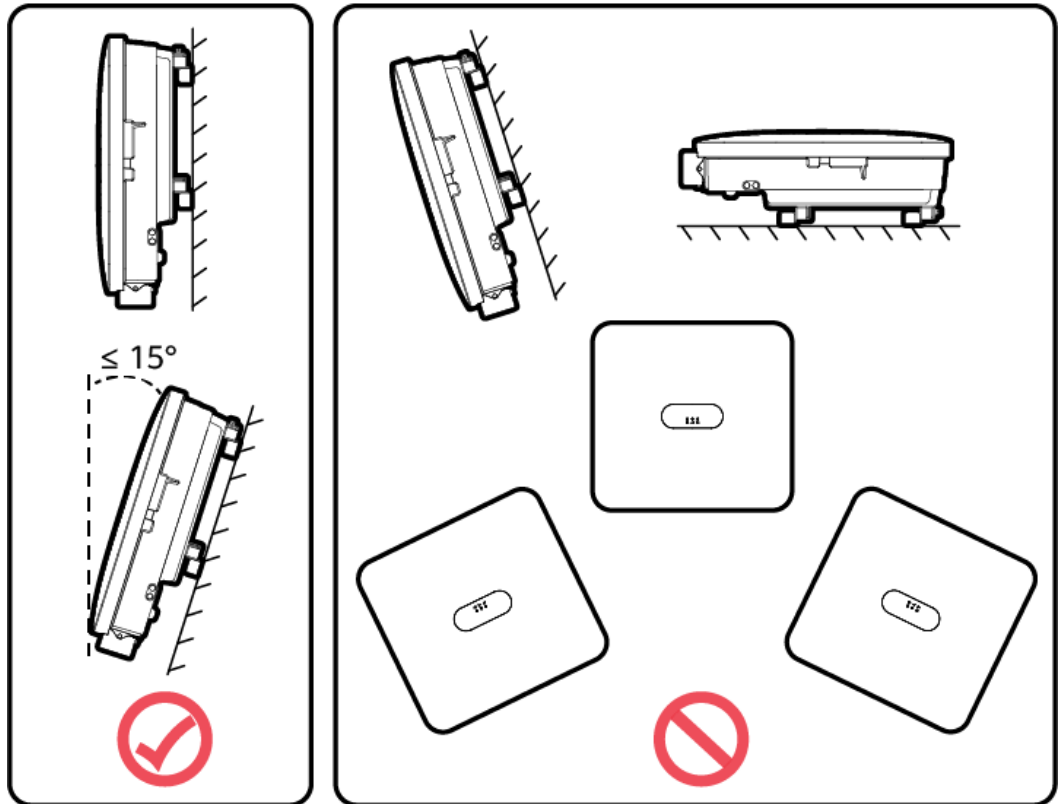
IH08W00005

4.2.3 Angle Requirements

The inverter can be wall-mounted or support-mounted. The installation angle requirements are as follows:

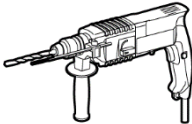
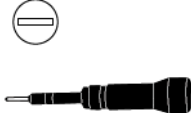



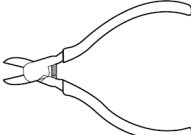
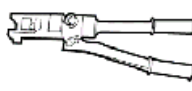
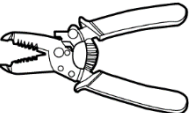
- Install the inverter vertically or at a maximum back tilt of 15 degrees to facilitate heat dissipation.
- Do not install the inverter at forward tilted, excessive backward tilted, side tilted, horizontal, or upside down positions.


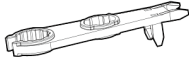



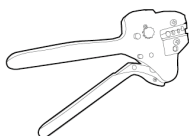



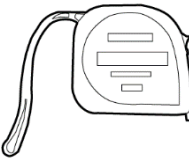


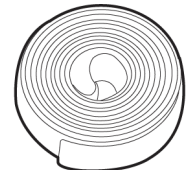
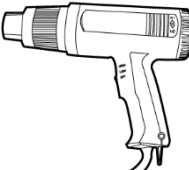




Figure 4-5 Installation angle




IH10H00013

4.3 Tools

Type	Tool			
Installation tool	 Hammer drill Drill bit: $\Phi 8$ mm, $\Phi 6$ mm	 Flat-head insulated torque screwdriver	 Phillips insulated torque screwdriver	 Hex insulated torque screwdriver
	 Insulated torque socket wrench	 Diagonal pliers	 Hydraulic pliers	 Wire stripper

Type	Tool			
	 Cable tie	 Removal wrench Model: H4TW0001	 Rubber mallet	 Utility knife
	 Cable cutter	 Crimping tool Model: H4TC0003	 Multimeter DC voltage measurement range ≥ 1100 V DC	 Vacuum cleaner
	 Marker	 Steel measuring tape	 Digital or bubble level	 Cord end terminal crimping tool
	 Heat shrink tubing	 Heat gun	-	-
Personal protective equipment (PPE)	 Insulated gloves	 Protective gloves	 Dust mask	 Safety shoes

Type	Tool			
	 Safety goggles	-	-	-

4.4 Checking Before the Installation

Checking Outer Packing

Before unpacking the inverter, check the outer packing for damage, such as holes and cracks, and check the inverter model. If any damage is found or the inverter model is not what you requested, do not unpack the device and contact your dealer as soon as possible.

 **NOTE**

You are advised to remove the packing materials within 24 hours before installing the inverter.

Checking Deliverables

NOTICE

After placing the equipment in the installation position, unpack it with care to prevent scratches. Keep the equipment stable during unpacking.

After unpacking the inverter, check that the deliverables are intact and complete. If any item is missing or damaged, contact your dealer.

 **NOTE**

For details about the quantity of deliverables, see the *packing list* in the packing case.

4.5 Moving the Inverter

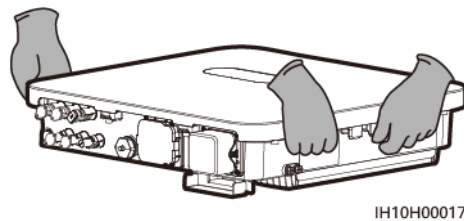
Procedure

- Step 1** To move the inverter, two individuals are required, with one positioned on each side. Carefully lift the inverter out of its packaging case and move it to the designated installation area.

CAUTION

- Move the inverter with care to prevent device damage and personal injury.
- Do not use the wiring terminals and ports at the bottom to support any weight of the inverter.
- When you need to temporarily place the inverter on the ground, use foam, paper, or other protection material to prevent damage to its enclosure.

Figure 4-6 Moving the inverter



----End

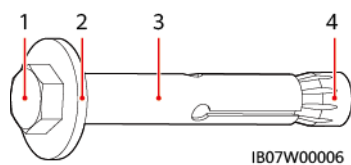
4.6 Installing the Inverter on a Wall

Context

NOTE

- M6x50 expansion bolts are delivered with the inverter. If the length and amount of the bolts do not meet installation requirements, prepare M6 stainless steel expansion bolts by yourself.
- The expansion bolts delivered with the inverter are mainly used for solid concrete walls. For other types of walls, prepare bolts by yourself and ensure that the wall meets the load bearing requirements of the inverter.

Figure 4-7 Expansion bolt structure



(1) Hexagonal bolt

(2) Flat washer

(3) Sleeve

(4) Conical nut

Procedure

Step 1 Install the mounting brackets.

1. Determine the positions for drilling holes using the marking-off template, level the holes using a level, and mark the positions using a marker.

2. Drill holes at the marked positions using a hammer drill and install expansion bolts.

DANGER

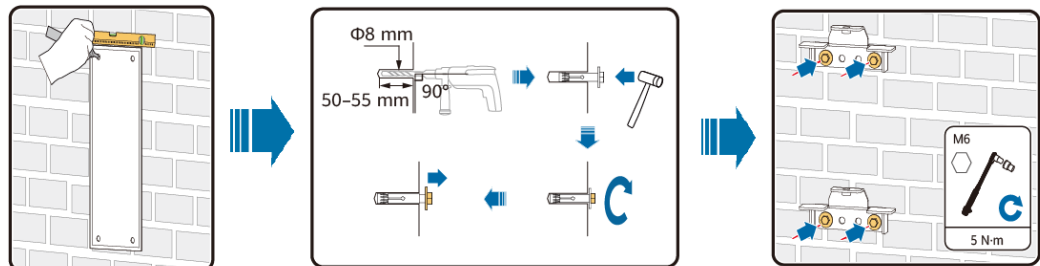
Avoid drilling holes in the utility pipes or cables attached to the back of the wall.

NOTICE

- To prevent dust inhalation or contact with eyes, wear safety goggles and a dust mask when drilling holes.
- Use a vacuum cleaner to clean up dust in and around the holes, and measure the spacing. If the holes are inaccurately positioned, drill the holes again in correct positions.
- Partially tighten the expansion bolts, and then remove the hexagonal bolts and flat washers from the expansion bolts.

3. Secure the mounting brackets.

Figure 4-8 Installing the mounting brackets



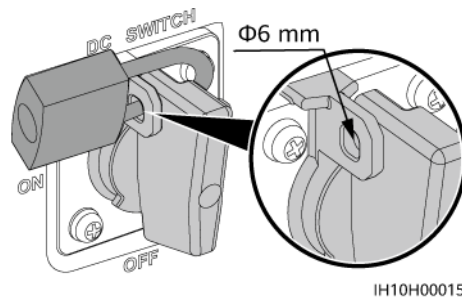
IH10H00082

Step 2 (Optional) Install a DC switch padlock.

NOTE

- For models used in Australia, the DC switch padlock needs to be installed according to the local standard to secure the DC switch (DC SWITCH) and prevent incorrect startup.
- The DC switch padlock needs to be prepared by the customer. Select a padlock based on the lock hole diameter ($\Phi 6$ mm) to ensure that the padlock can be installed smoothly.
- An outdoor waterproof padlock is recommended.
- Keep the padlock key properly.

Figure 4-9 Installing a DC switch padlock

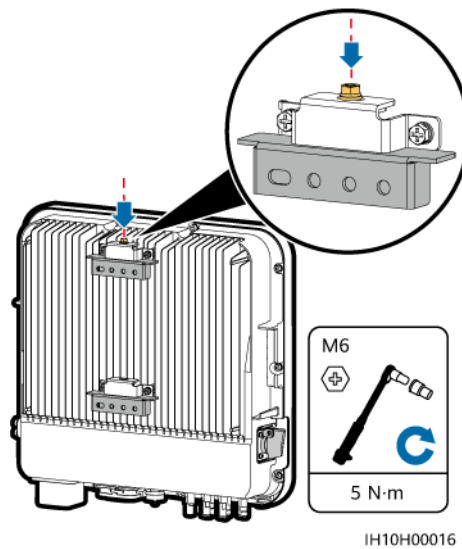


Step 3 Install the inverter on the mounting brackets.

NOTE

The M6x16 hexagonal bolts delivered with the inverter are used to secure the mounting bracket and hanging kit in the upper part.

Figure 4-10 Installing the inverter



----End

4.7 Installing the Inverter on a Support

Prerequisites

Prepare M6 stainless steel bolt assemblies (including flat washers, spring washers, and M6 bolts) with appropriate lengths as well as matched flat washers and nuts based on the support specifications.

Procedure

Step 1 Install the mounting brackets.

1. Determine the positions for drilling holes using the marking-off template, and then mark the positions with a marker.

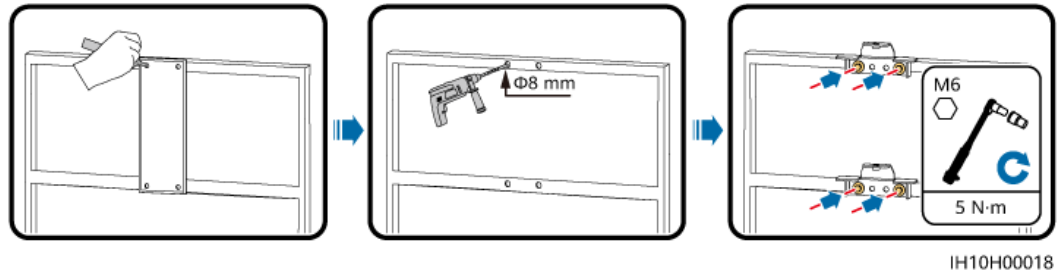
2. Drill holes using a hammer drill.

 **NOTE**

You are advised to apply anti-rust paint on the hole positions for protection.

3. Secure the mounting brackets.

Figure 4-11 Installing the mounting brackets

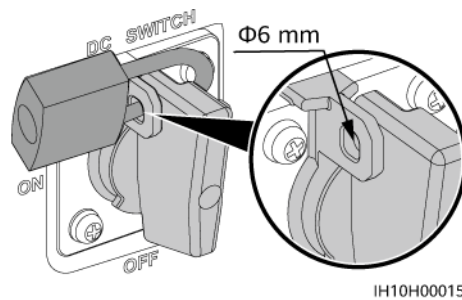


Step 2 (Optional) Install a DC switch padlock.

 **NOTE**

- For models used in Australia, the DC switch padlock needs to be installed according to the local standard to secure the DC switch (DC SWITCH) and prevent incorrect startup.
- The DC switch padlock needs to be prepared by the customer. Select a padlock based on the lock hole diameter ($\Phi 6$ mm) to ensure that the padlock can be installed smoothly.
- An outdoor waterproof padlock is recommended.
- Keep the padlock key properly.

Figure 4-12 Installing a DC switch padlock

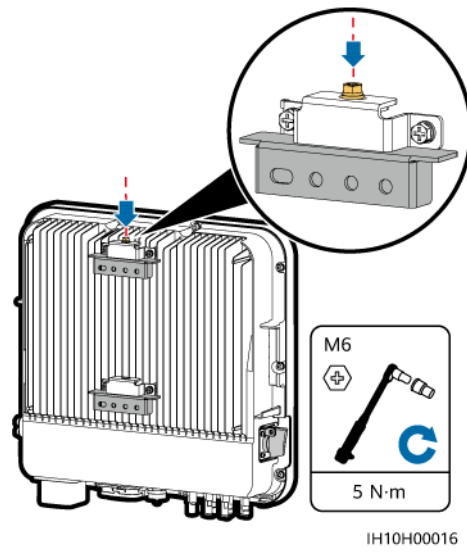


Step 3 Install the inverter on the mounting brackets.

 **NOTE**

The M6x16 hexagonal bolts delivered with the inverter are used to secure the mounting bracket and hanging kit in the upper part.

Figure 4-13 Installing the inverter



----End

5 Electrical Connections

5.1 Precautions

 **DANGER**

When exposed to sunlight, the PV arrays supply DC voltage to the inverter. Before connecting cables, ensure that all **DC SWITCH** on the inverter are OFF. Otherwise, the high voltage of the inverter may result in electric shocks.

 **DANGER**

- The site must be equipped with qualified fire fighting facilities, such as fire sand and carbon dioxide fire extinguishers.
 - Wear personal protective equipment and use dedicated insulated tools to avoid electric shocks or short circuits.
-

 **WARNING**

- The equipment damage caused by incorrect cable connections is beyond the warranty scope.
 - Only certified electrician can perform electrical terminations.
 - Operation personnel must wear PPE when connecting cables.
 - Before connecting cables to ports, leave enough slack to reduce the tension on the cables and prevent poor cable connections.
-

CAUTION

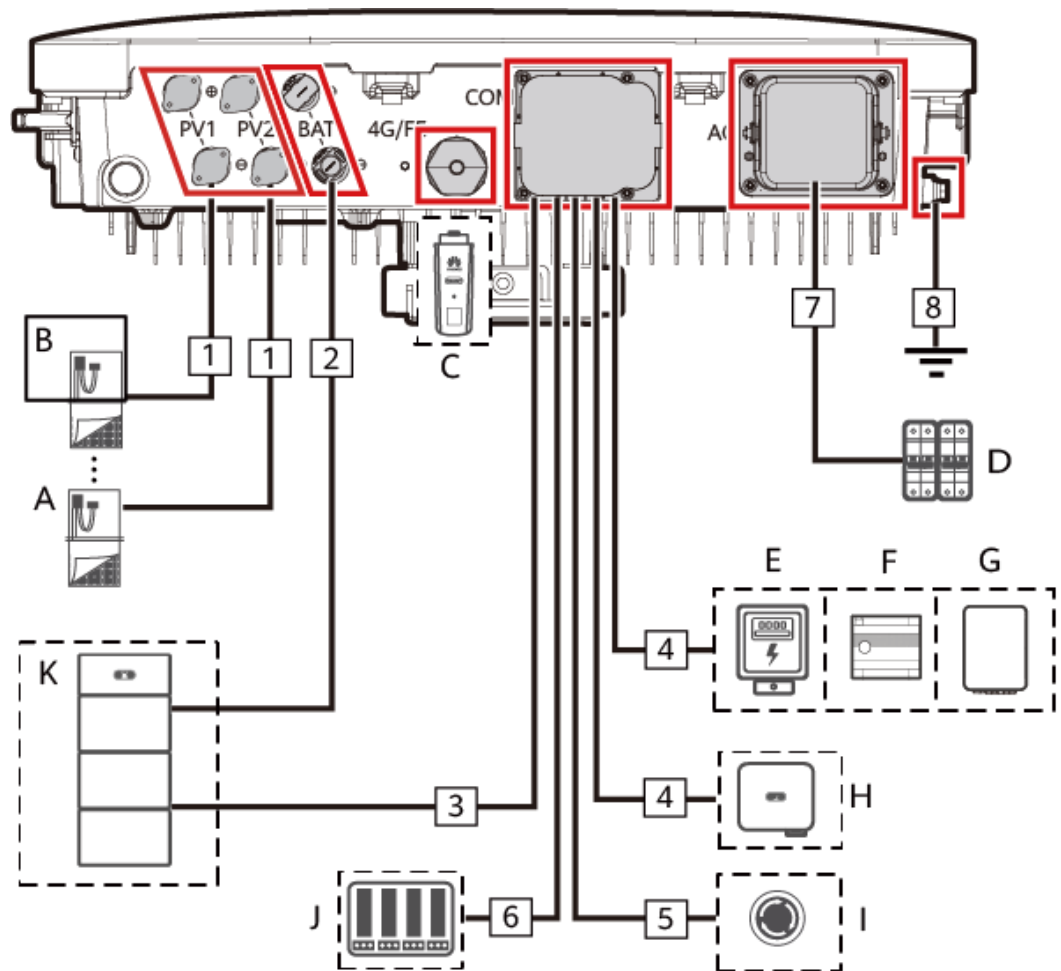
- Stay away from the equipment when preparing cables to prevent cable scraps from entering the equipment. Cable scraps may cause sparks and result in personal injury and equipment damage.

NOTE

The cable colors shown in the electrical connection diagrams provided in this section are for reference only. Select cables in accordance with local cable specifications (green-and-yellow cables are only used for protective earthing).

5.2 Preparing Cables

Figure 5-1 Inverter cable connections (dashed boxes indicate optional components)



IH10H00065

Table 5-1 Component description

No.	Component	Description	Source
A	PV module	<ul style="list-style-type: none"> • A PV string consists of PV modules connected in series. • The inverter supports two PV string inputs. 	Prepared by the customer
B	Smart PV Optimizer	Supported models: SUN2000-(600W-P, 450W-P2) and MERC-600W-PA0 ^[1]	Purchased from Huawei
C	Smart Dongle ^[2]	Supported models: <ul style="list-style-type: none"> • WLAN-FE Smart Dongle: SDongleA-05 • 4G Smart Dongle: SDongleB-06 	Purchased from Huawei
D	AC switch	<p>To ensure that the inverter can be safely disconnected from the power grid when an exception occurs, connect an AC switch to the AC side of the inverter. Select an appropriate AC switch in accordance with local industry standards and regulations. Huawei recommends the following switch specifications:</p> <p>It is recommended that you use a three-phase AC circuit breaker with a rated voltage greater than or equal to 415 V AC and a rated current of:</p> <ul style="list-style-type: none"> • 8K: 25 A • 12K: 32 A 	Prepared by the customer
E	Power meter ^[3]	Recommended models: DTSU666-H, DTSU71, DHSU1079-CT, and YDS60-C24 ^[4]	Purchased from Huawei
F	EMMA ^[5]	Supported models: EMMA-A01 and EMMA-A02	Purchased from Huawei
G	SmartGuard	<p>The SmartGuard can be used to switch between the on-grid and off-grid states of the inverter.</p> <p>Supported models: SmartGuard-63A-T0 and SmartGuard-63A-AUT0</p>	Purchased from Huawei
H	Inverter	Select a proper model as required.	Purchased from Huawei

No.	Component	Description	Source
I	Rapid shutdown switch	Select a proper model as required.	Prepared by the customer
J	Power grid scheduling device	Select the device that meets the power grid scheduling requirements.	Provided by the local power grid company
K	Battery	The inverter can connect to the LUNA2000.	Purchased from Huawei
<p>Note [1]:</p> <ul style="list-style-type: none"> The SUN2000-(600W-P, 450W-P2) and MERC-600W-PA0 cannot be used together for the same inverter. Optimizers must be configured for all PV modules connected to the SUN5000 inverter. Otherwise, the inverter cannot be started. <p>Note [2]: For details about how to operate a WLAN-FE Smart Dongle SDongleA-05, see SDongleA-05 Smart Dongle Quick Guide (WLAN-FE). For details about how to operate a 4G Smart Dongle SDongleB-06, see SDongleB-06 Smart Dongle Quick Guide (4G). You can obtain these documents at https://support.huawei.com/enterprise by searching for models.</p> <p>Note [3]: For details about how to operate a power meter, see DTSU666-H 100 A and 250 A Smart Power Sensor User Manual, DTSU71 Smart Power Sensor Quick Guide, DHSU1079-CT Smart Power Sensor Quick Guide, or YDS60-C24 Smart Power Sensor Quick Guide.</p> <p>Note [4]: Retain the default baud rates for the power meters. If they are changed, the power meters may go offline, generate alarms, or affect the inverter output power.</p> <p>Note [5]: For details about how to operate the EMMA, see EMMA-(A01, A02) Quick Guide.</p>			

Table 5-2 Cable description

No.	Name	Type	Conductor Cross-Sectional Area	Cable Outer Diameter	Source
1	DC input power cable	Common outdoor PV cable in the industry	4–6 mm ²	5.5–9 mm	Prepared by the customer
2	(Optional) Battery cable	Common outdoor PV cable in the industry	4–6 mm ²	5.5–9 mm	Prepared by the customer

No.	Name	Type	Conductor Cross-Sectional Area	Cable Outer Diameter	Source
3	(Optional) Battery signal cable	Cat 5E outdoor shielded network cable	-	-	Purchased from Huawei
4	(Optional) RS485 communications cable	Two-core outdoor shielded twisted pair cable	0.2–1 mm ²	4–11 mm	Prepared by the customer
5	(Optional) Signal cable to the rapid shutdown switch	Two-core outdoor shielded twisted pair cable	0.2–1 mm ²	4–11 mm	Prepared by the customer
6	(Optional) Grid scheduling signal cable	Five-core outdoor cable	0.2–1 mm ²	4–11 mm	Prepared by the customer
7	AC output power cable	Outdoor copper cable	4–6 mm ²	10–21 mm	Prepared by the customer
8	PE cable	Single-core outdoor copper cable	4–6 mm ²	10–21 mm	Prepared by the customer

 **NOTE**

- The minimum cable diameter must meet local standards.
- The factors that affect cable selection include the rated current, cable type, routing mode, ambient temperature, and maximum expected line loss.

5.3 Connecting a PE Cable

Precautions

 **DANGER**

- Ensure that the PE cable is securely connected. Otherwise, electric shocks may occur.
- Do not connect the neutral wire to the enclosure as a PE cable. Otherwise, electric shocks may occur.

 **NOTE**

- The PE point at the AC output port is used only as a PE equipotential bonding point, and cannot substitute for the PE point on the enclosure.
- It is recommended that silicone grease or paint be applied around the ground terminal after the PE cable is connected.
- You can enable or disable phase-to-ground short-circuit protection on the app (choose **Settings > Feature parameters > Phase-to-ground short-circuit protection**) to address the situation in which a phase wire is short-circuited to PE. If this function is disabled, the inverter detects the alarm and can connect to the power grid and generate power normally. This function complies with NB/T 32004 and CHINA-LV220/380.

Additional Information

The inverter provides the grounding detection function. This function is used to check whether the inverter is properly grounded before the inverter starts, or check whether the ground cable is disconnected when the inverter is running. This function is only available under limited conditions. To ensure the safe operation of the inverter, properly ground the inverter according to the connection requirements of the PE cable. For some power grid types, if the output side of the inverter is connected to an isolation transformer, ensure that the inverter is properly grounded and then set **Grounding Exception Detection** to **Disable** so that the inverter can run properly.

- According to IEC 62109, to ensure the safe operation of the inverter in the case of PE cable damage or disconnection, properly connect the PE cable of the inverter and ensure that it meets at least one of the following requirements before the grounding detection function becomes invalid.
 - If the PE terminal of the AC connector is not connected, the PE cable on the enclosure must be a single-core outdoor copper cable with a cross-sectional area of at least 10 mm².
 - Use cables with the same diameter as the AC output power cable and ground the PE terminal on the AC connector and the ground screws on the enclosure.
- In some countries and regions, the inverter must have additional ground cables. In this case, use cables with the same diameter as the AC output power cable to ground the PE terminal of the AC connector and the ground screws of the enclosure, respectively.

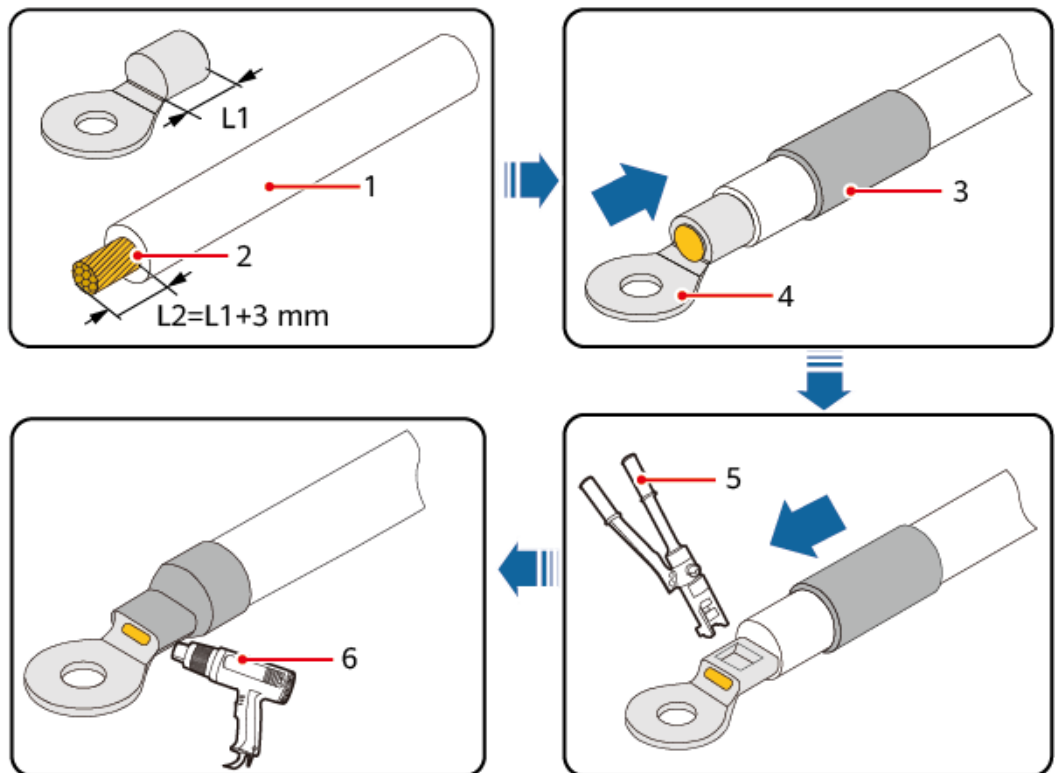
Procedure

Step 1 Crimp an OT terminal.

NOTICE

- Avoid scratching the core wire when stripping a cable.
- The cavity formed after the conductor crimp strip of the OT terminal is crimped must wrap the core wire completely. The core wire must make close contact with the OT terminal.
- Wrap the wire crimping area with heat shrink tubing or insulation tape. The heat shrink tubing is used as an example.
- Use a heat gun carefully to avoid heat damage to the equipment.

Figure 5-2 Crimping an OT terminal



IS06Z00001

(1) Cable

(2) Core wire

(3) Heat shrink tubing

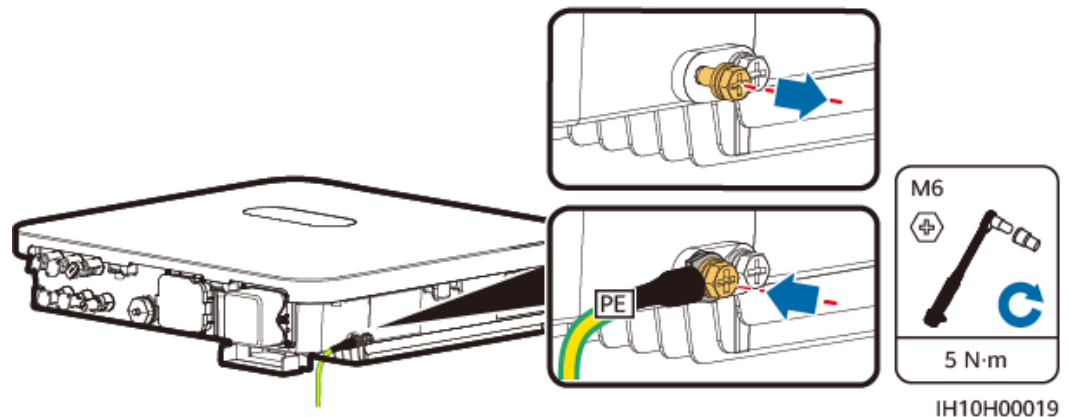
(4) OT terminal

(5) Hydraulic pliers

(6) Heat gun

Step 2 Connect the PE cable.

Figure 5-3 Connecting the PE cable



----End

5.4 Connecting an AC Output Power Cable

Precautions

It is recommended that a three-phase AC switch be installed on the AC side of the inverter. To ensure that the inverter can safely disconnect itself from the power grid when an exception occurs, select a proper overcurrent protection device in compliance with local power distribution regulations.

WARNING

- Do not connect loads between an inverter and an AC switch that directly connects to the inverter. Otherwise, the switch may trip by mistake.
 - If an AC switch is used with specifications beyond local standards, regulations, or the Company's recommendations, the switch may fail to turn off in a timely manner in case of exceptions, causing serious faults.
-

CAUTION

Each inverter shall be equipped with an AC output switch. Multiple inverters shall not connect to the same AC switch.

The inverter is installed with an integrated residual current monitoring unit. When the inverter detects that residual current exceeds the permitted value, it disconnects from the power grid quickly.

NOTICE

- If the external AC switch provides the leakage protection function, the rated residual operating current must be greater than or equal to 300 mA.
 - If multiple inverters are connected to the master leakage protection device through their external AC switches, the rated residual operating current of the device must be greater than or equal to the number of inverters x 300 mA.
 - The AC switch cannot be a knife switch.
-

Procedure

Step 1 Connect the AC output power cable to the AC connector.

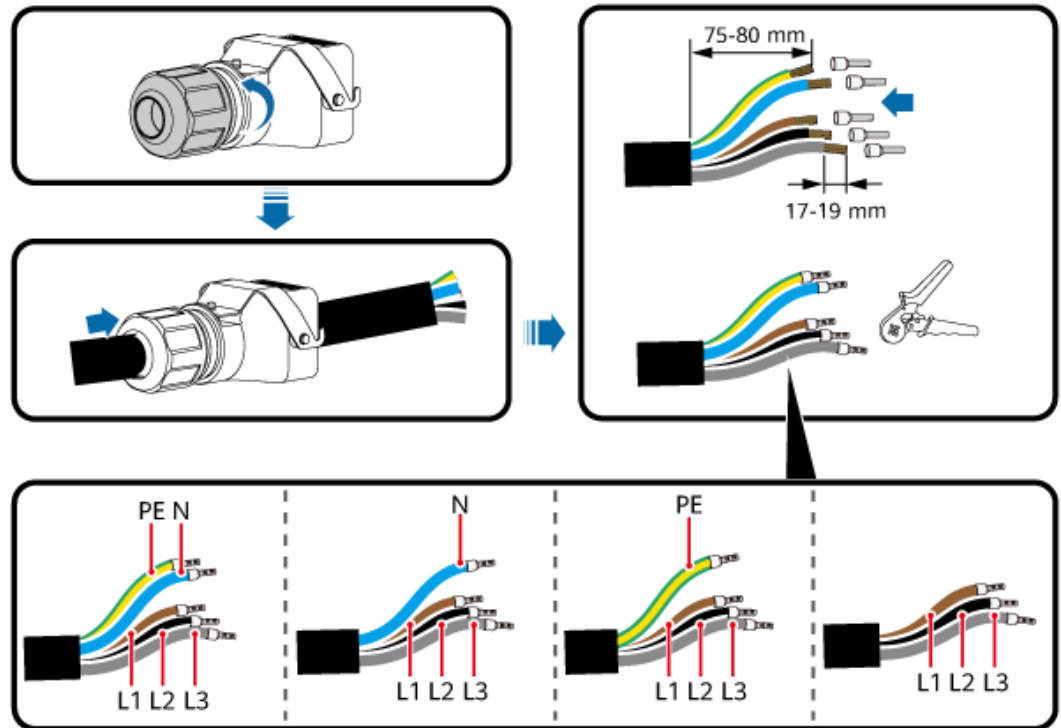
NOTICE

- Ensure that the cable jacket is inside the connector.
 - Insert the exposed core wires completely into the holes.
 - Connect the AC output cable securely. Otherwise, the device may fail to operate properly or the AC connector may be damaged.
 - Ensure that the cable is not twisted.
-

NOTICE

Strip the insulation layers of the AC output power cable by the recommended length (17–19 mm) to ensure that the cable conductors are completely inside the conductor insertion points and no insulation layer is pressed into the conductor insertion points. Tighten the cable conductors to a torque of 2.8–3.2 N·m. Otherwise, the device may fail to run properly or be damaged during operation.

Figure 5-4 Connecting the AC output power cable to the AC connector



IH10H00021

NOTE

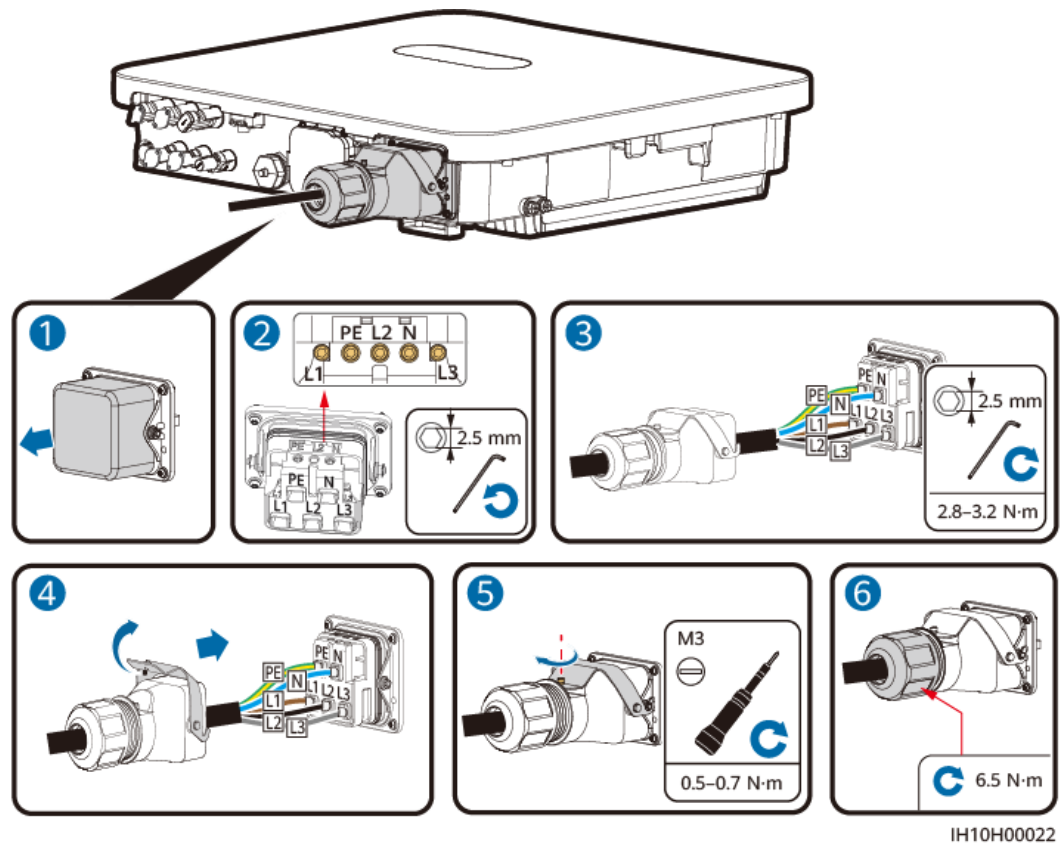
The cable colors shown in the figures are for reference only. Select an appropriate cable according to the local standards.

Step 2 Connect the AC connector together with the AC output power cable to the AC output port.

NOTICE

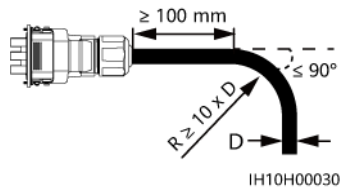
Ensure that the AC connector is connected securely.

Figure 5-5 Securing the AC connector



Step 3 Check the route of the AC output power cable.

Figure 5-6 Cabling requirements



----End

Disconnection

Perform the steps in reverse order to disconnect the cable.

5.5 Connecting DC Input Power Cables

Precautions

 **DANGER**

- Before connecting the DC input power cables, ensure that the DC voltage is within the safe range (lower than 60 V DC) and that the DC SWITCH on the inverter is OFF. Otherwise, the high voltage may result in electric shocks.
 - When the inverter is operating, do not perform maintenance or operations on the DC input power cables, such as connecting or disconnecting a PV string or a PV module in the PV string. Otherwise, electric shocks may occur.
 - If no PV string connects to a DC input terminal of the inverter, do not remove the waterproof cap from the DC input terminal. Otherwise, the protection level of the inverter will decrease.
-

 **WARNING**

Ensure that the following conditions are met. Otherwise, the inverter may be damaged or even a fire may occur.

- PV modules connected in series in each PV string are of the same specifications.
 - The maximum open-circuit voltage of each PV string must be lower than or equal to 1100 V DC under any circumstances.
 - The polarities of electric connections are correct on the DC input side. The positive and negative terminals of a PV string connect to corresponding positive and negative DC input terminals of the inverter.
 - If a DC input power cable is reversely connected, do not immediately operate on the DC SWITCH or positive/negative connectors. Wait until the night when solar irradiance declines and the PV string current drops to below 0.5 A. Then set the DC SWITCH to OFF, remove the positive and negative connectors, and correct the polarities of the DC input power cable.
-

 **WARNING**

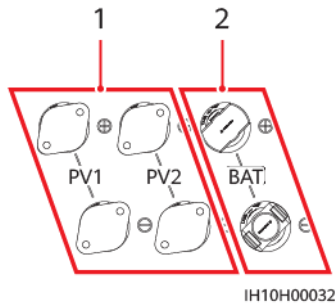
During the installation of PV strings and the inverter, the positive or negative terminals of PV strings may be short-circuited to ground if the power cables are not properly installed or routed. In this case, an AC or DC short circuit may occur and damage the inverter. The resulting device damage is not covered under any warranty.

NOTICE

The output of the PV string connected to the inverter cannot be grounded. Ensure that the PV module output is well insulated to ground.

Terminal Description

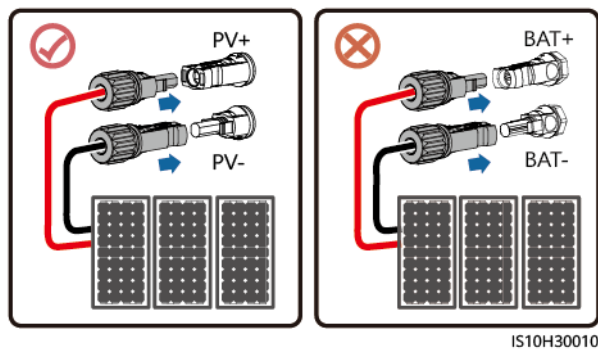
Figure 5-7 Terminals



(1) DC input terminals

(2) Battery terminals

Figure 5-8 Connection



Procedure

Step 1 Assemble DC connectors.

CAUTION

Use the positive and negative metal terminals and DC connectors delivered with the inverter. Using incompatible positive and negative metal terminals and DC connectors may result in serious consequences. The resulting device damage is not covered by the product warranty.

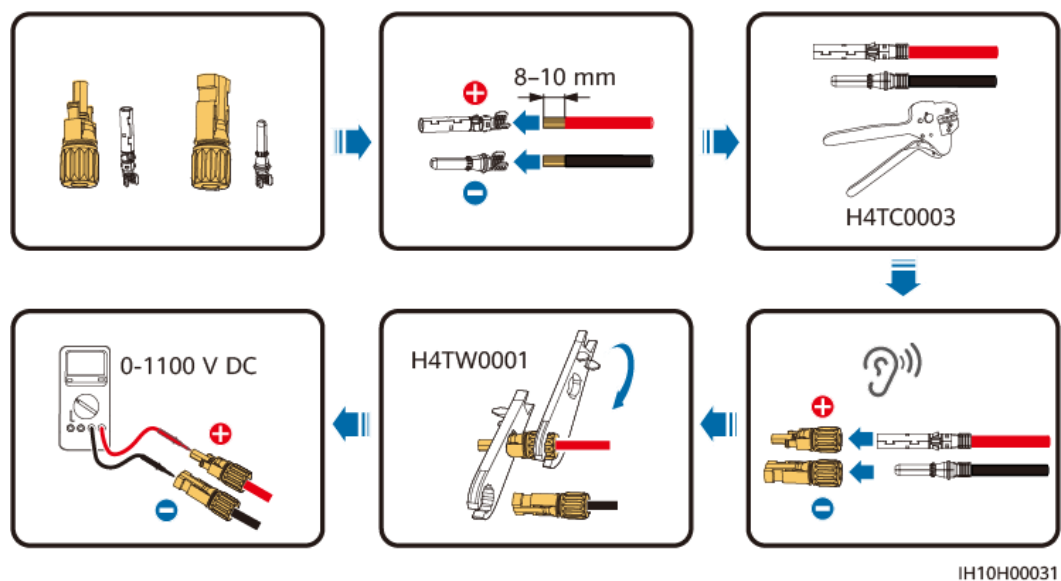
NOTICE

- Cables with high rigidity, such as armored cables, are not recommended as DC input power cables, because poor contact may be caused by the bending of the cables.
- Before assembling DC connectors, label the cable polarities correctly to ensure correct cable connections.
- After crimping the positive and negative metal terminals, pull the DC input power cables back to ensure that they are connected securely.
- Insert the crimped metal terminals of the positive and negative power cables into the appropriate positive and negative connectors. Then pull back the DC input power cables to ensure that they are connected securely.

NOTE

- The multimeter must have a DC voltage range of at least 1100 V. If the voltage is a negative value, the DC input polarity is incorrect. Rectify the connection. If the voltage is greater than 1100 V, too many PV modules are connected to the same string. Remove some PV modules.
- If PV strings are configured with optimizers, check the cable polarities by referring to the *Smart PV Optimizer Quick Guide*.

Figure 5-9 Assembling DC connectors



Step 2 Insert the positive and negative connectors into corresponding DC input terminals on the inverter.

WARNING

Before inserting the positive and negative connectors into the positive and negative DC input terminals of the inverter, ensure that the DC SWITCH is set to OFF.

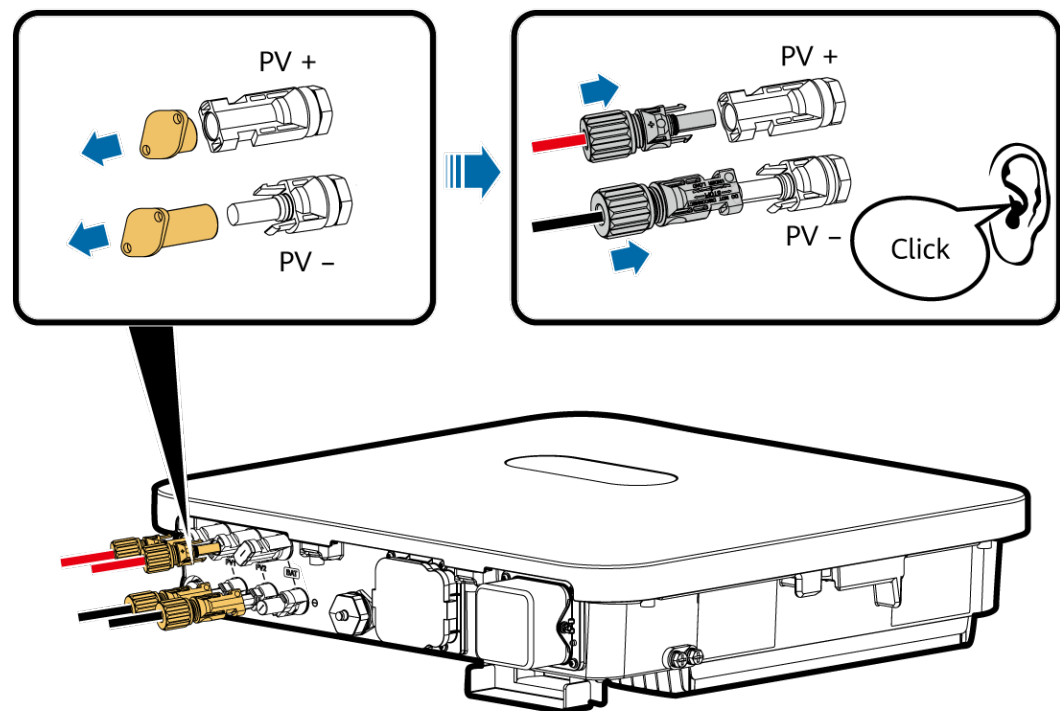
NOTICE

During DC input power cabling, leave at least 50 mm of slack. The axial tension on PV connectors must not exceed 80 N. Radial stress or torque must not be generated on PV connectors.

NOTICE

If a DC input power cable is reversely connected and the DC SWITCH is set to ON, do not immediately operate on the DC SWITCH or the positive/negative connectors. Otherwise, the device may be damaged. The resulting device damage is not covered by the product warranty. Wait until the night when solar irradiance declines and the PV string current drops to below 0.5 A. Then set the DC SWITCH to OFF, remove the positive and negative connectors, and correct the polarities of the DC input power cable.

Figure 5-10 Connecting DC input power cables



IH10H00033

----End

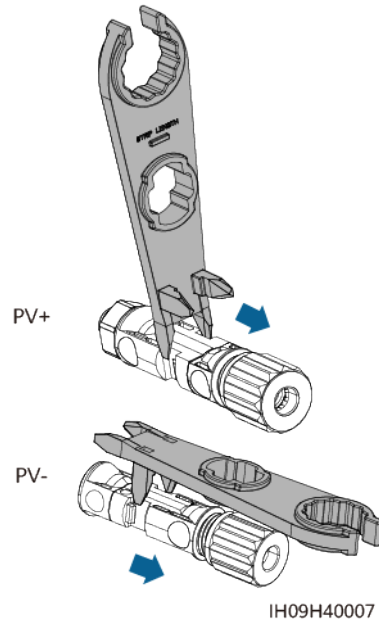
Removing DC Connectors

WARNING

Before removing the positive and negative connectors, ensure that the DC SWITCH is set to OFF.

To remove the positive and negative connectors from the inverter, insert an open-end wrench into the notch and press the wrench with an appropriate force.

Figure 5-11 Removing a DC connector



5.6 (Optional) Connecting Battery Cables

Precautions

⚠ DANGER

- Battery short circuits may cause personal injury. The high transient current generated by a short circuit may release a surge of power and cause fire.
 - Do not connect, disconnect, or perform other maintenance operations on battery cables when the inverter is running. Otherwise, electric shocks may occur.
 - Before connecting the battery cables, ensure that the **DC SWITCH** on the inverter and all the switches connecting to the inverter are **OFF**, and that the inverter has no residual electricity. Otherwise, the high voltage of the inverter and battery may result in electric shocks.
 - If no battery connects to the inverter, do not remove the waterproof covers from the battery terminals. Otherwise, the ingress protection (IP) rating of the inverter will be affected. If a battery connects to the inverter, keep the waterproof covers properly and reinstall them immediately after removing the connectors.
-

 **WARNING**

- Do not connect loads between the inverter and the battery.
 - Ensure that the battery cables are connected to the battery terminals of the inverter. If a battery cable is connected incorrectly to the DC input terminal of the inverter, the inverter may be damaged or even a fire may occur.
 - The battery cables must be connected correctly. That is, the positive and negative terminals of the battery connect to the positive and negative battery terminals of the inverter, respectively. Otherwise, the inverter may be damaged or even a fire may occur.
-

 **WARNING**

If power cables are not installed or routed as required during the installation of the inverter and the battery, the positive or negative terminal of the battery will be short-circuited to ground. In this case, an AC or DC short circuit may occur and damage the inverter. The resulting device damage is not covered by the product warranty.

Procedure

- Step 1** Assemble the positive and negative connectors by referring to [5.5 Connecting DC Input Power Cables](#).

 **DANGER**

- The battery voltage will result in serious injury. Use dedicated insulation tools to connect cables.
 - Ensure that cables are connected correctly between the terminals of the battery and the battery switch, and between the battery switch and the battery terminals of the inverter.
-

NOTICE

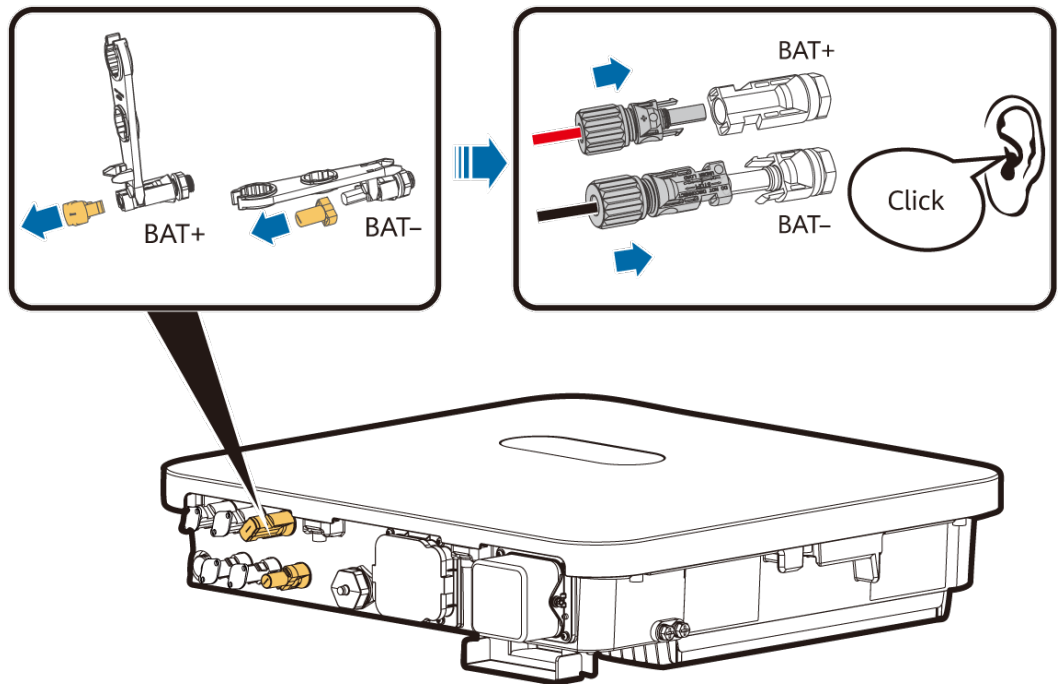
Cables with high rigidity, such as armored cables, are not recommended as battery cables, because poor contact may be caused by the bending of the cables.

- Step 2** Insert the positive and negative connectors into corresponding battery terminals on the inverter.

NOTICE

After the positive and negative connectors snap into place, pull the battery cables back to ensure that they are connected securely.

Figure 5-12 Connecting battery cables



IH10H00023

----End

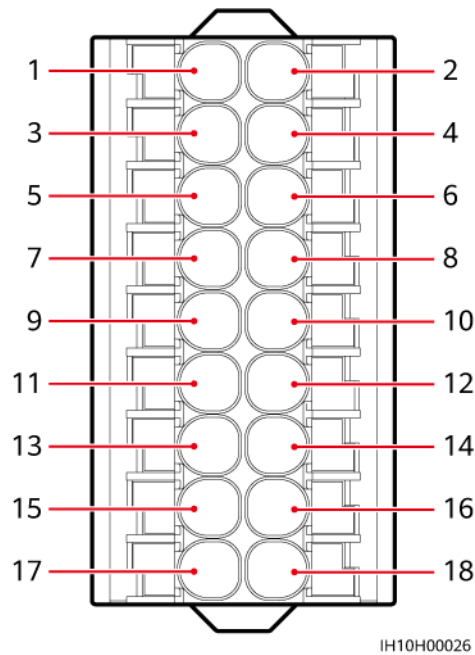
5.7 Connecting Signal Cables

Communications Ports

NOTICE

- When laying out a signal cable, separate it from power cables and keep it away from strong interference sources to prevent communication interruption.
- Ensure that the protection layer of the signal cable is inside the connector, surplus core wires are cut off from the protection layer, the exposed core wires are inserted completely into the holes, and the cable is connected securely.
- Use rubber plugs to fill the cable holes where no cables are routed through the waterproof rubber rings, and tighten the locking caps to the recommended torque.

Figure 5-13 COM: 18-pin terminal

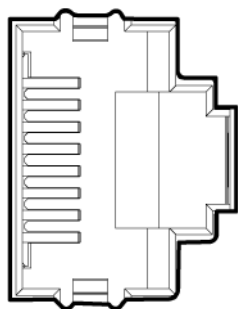


IH10H00026

Pin	Definition	Function	Description	Pin	Definition	Function	Description
1	485A1	RS485A, RS485 differential signal+	Used for cascading inverters or connecting to the RS485 signal port of the EMMA or SmartGuard. When cascaded inverters and the EMMA coexist, they share the 485A1 and 485B1 ports.	2	CANA1	CAN differential signal, high	Reserved port
3	485B1	RS485B, RS485 differential signal-		4	CANA2	CAN differential signal, low	
5	PE	Shield layer grounding	-	6	PE	Shield layer grounding	-
7	DIN6	Digital input signal 6+	Used as the feedback signal port for the SmartGuard	8	DIN1	Digital input signal 1+	Connecting to the dry contact for power grid scheduling
9	GND	GND of DIN6	-	10	DIN2	Digital input signal 2+	

Pin	Definition	Function	Description	Pin	Definition	Function	Description
11	485A2	RS485A, RS485 differential signal+	Connecting to the RS485 signal port of a power meter	12	DIN3	Digital input signal 3+	
13	485B2	RS485B, RS485 differential signal-		14	DIN4	Digital input signal 4+	<ul style="list-style-type: none"> • Connecting to the dry contact for power grid scheduling • Connecting to the ripple control receiver for load power control
15	GND_OUT	12 V power output-	Reserved port	16	GND	GND of DIN1, DIN2, DIN3, DIN4, or DIN5	Connecting to GND of DIN1, DIN2, DIN3, DIN4, or DIN5
17	12V_OUT	12 V power output+	Reserved port	18	DIN5	Rapid shutdown	Used for the rapid shutdown DI signal or connecting to the signal cable of an NS protection device

Figure 5-14 COM: RJ45 network port



IH10H00051

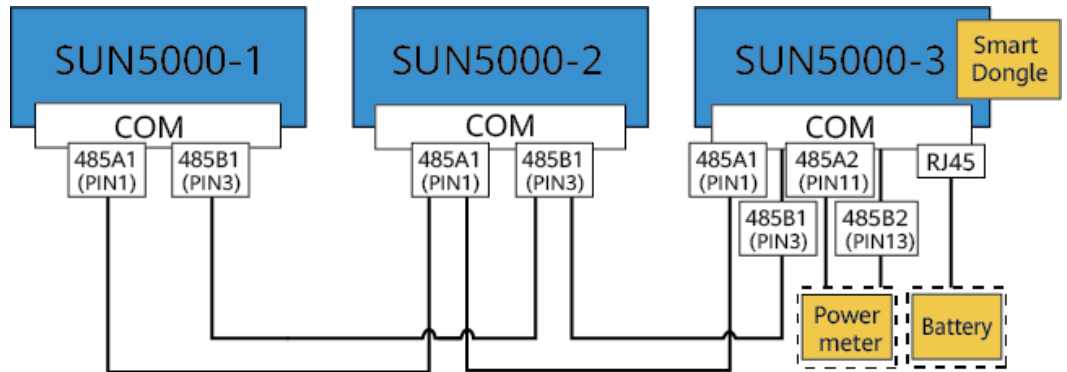
NOTE

The RJ45 network port is located in the COM port and is used to connect to a battery.

Communication Networking Mode

- Smart Dongle networking

Figure 5-15 Smart Dongle networking (dashed boxes indicate optional components)

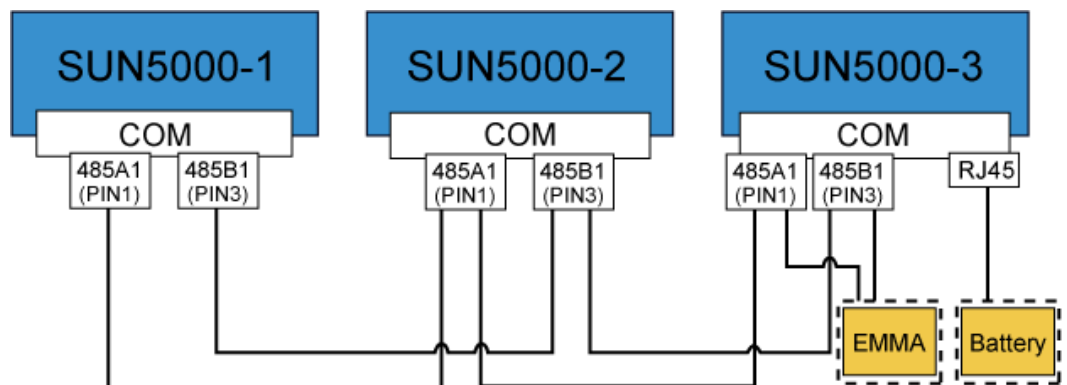


IH10H00066

NOTE

- A power meter is required for export limitation. Select a power meter based on the site requirements.
- The power meter and the Smart Dongle must be connected to the same inverter.
- In the PV+ESS scenario, a maximum of three inverters can be cascaded. The inverter connected to the Smart Dongle must be connected to the ESS. Whether other inverters are connected to the ESS is optional.
- EMMA networking

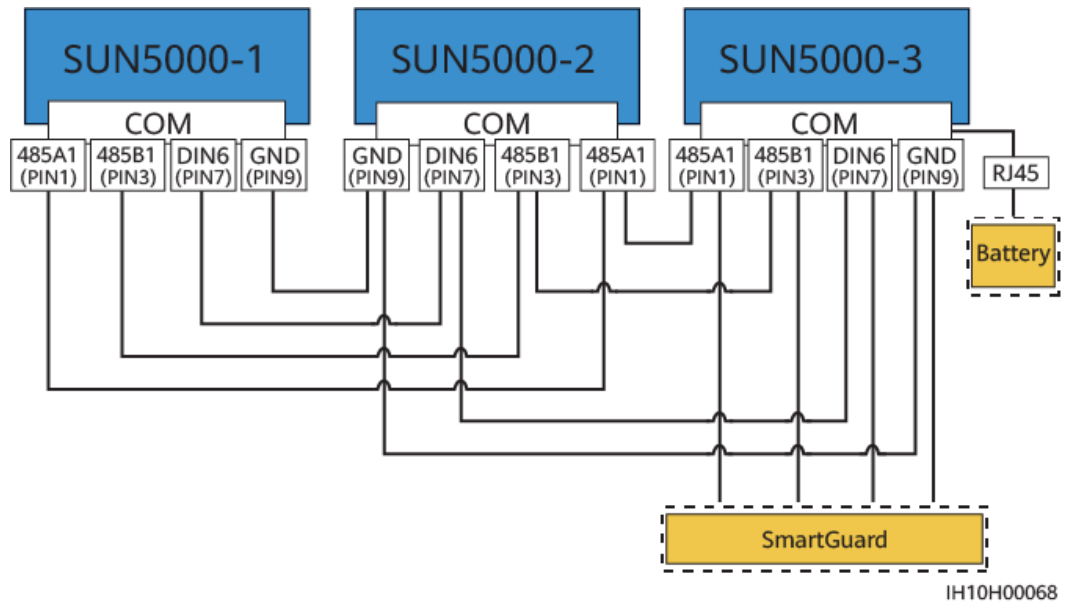
Figure 5-16 EMMA networking (dashed boxes indicate optional components)



IH10H00067

- SmartGuard networking

Figure 5-17 SmartGuard networking (dashed boxes indicate optional components)

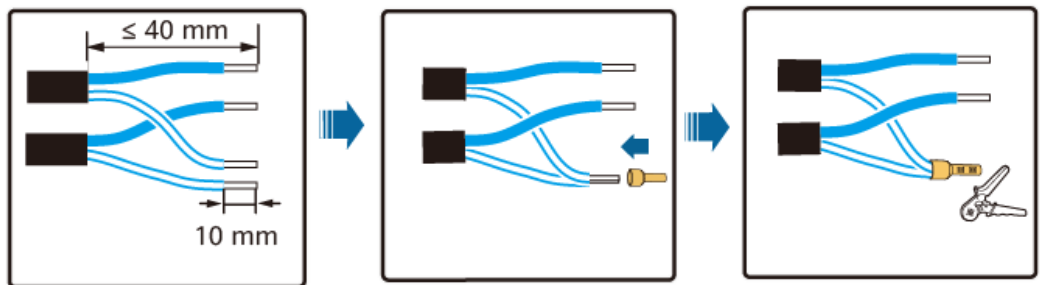


Requirements for Signal Cables

NOTICE

- Ensure that the protection layer of the cable is in the connector. The surplus core should be cut off from the protection layer.
- Ensure that the exposed core is totally inserted into the cable hole.
- Ensure that the signal cables are connected securely.
- Ensure that the cables are not twisted.
- If multiple signal cables need to be connected to a single connector, ensure that the outer diameters of the signal cables are the same.

Figure 5-18 Crimping two signal cables

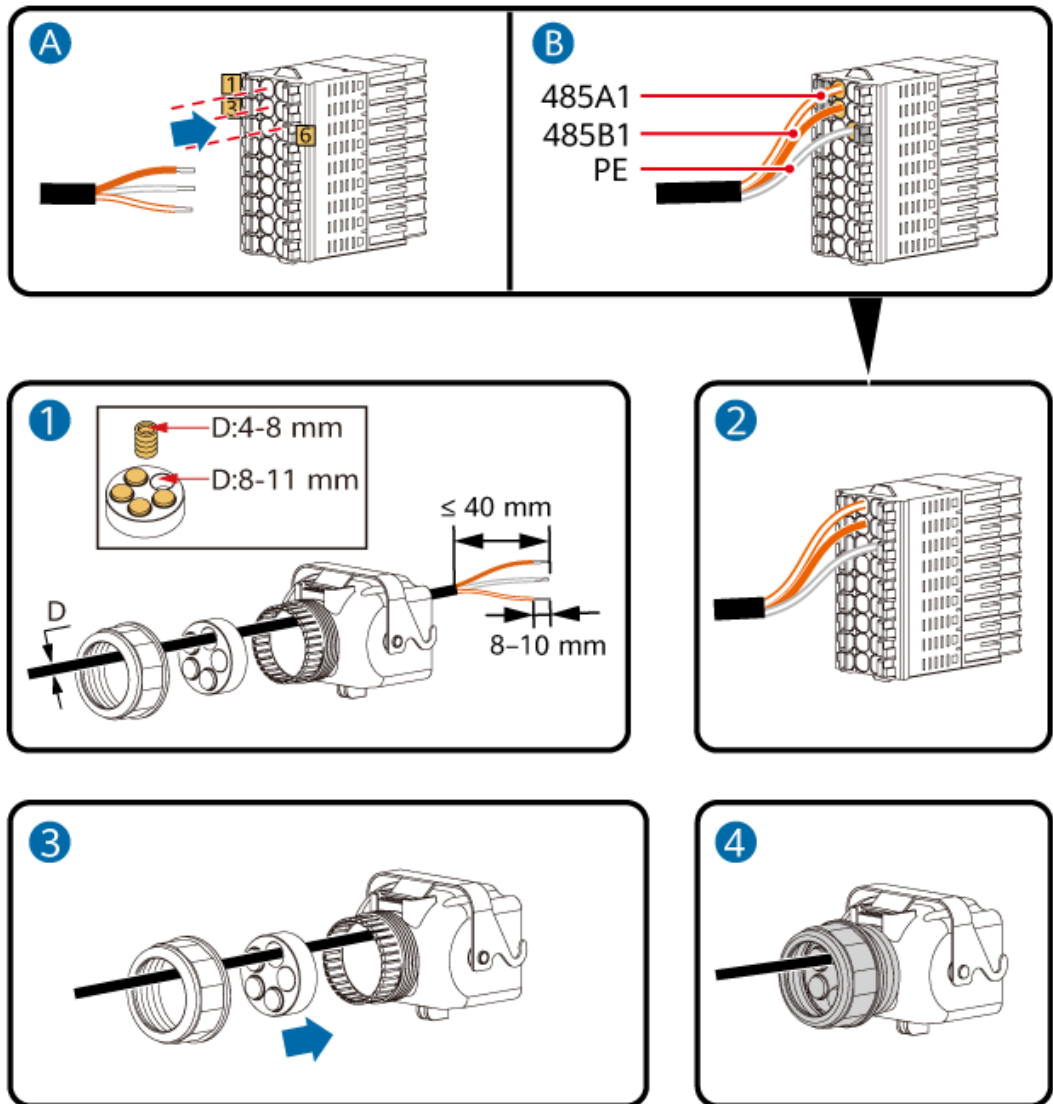


5.7.1 Connecting RS485 Communications Cables (Inverter Cascading)

Procedure

Step 1 Connect the signal cable to the signal cable terminal.

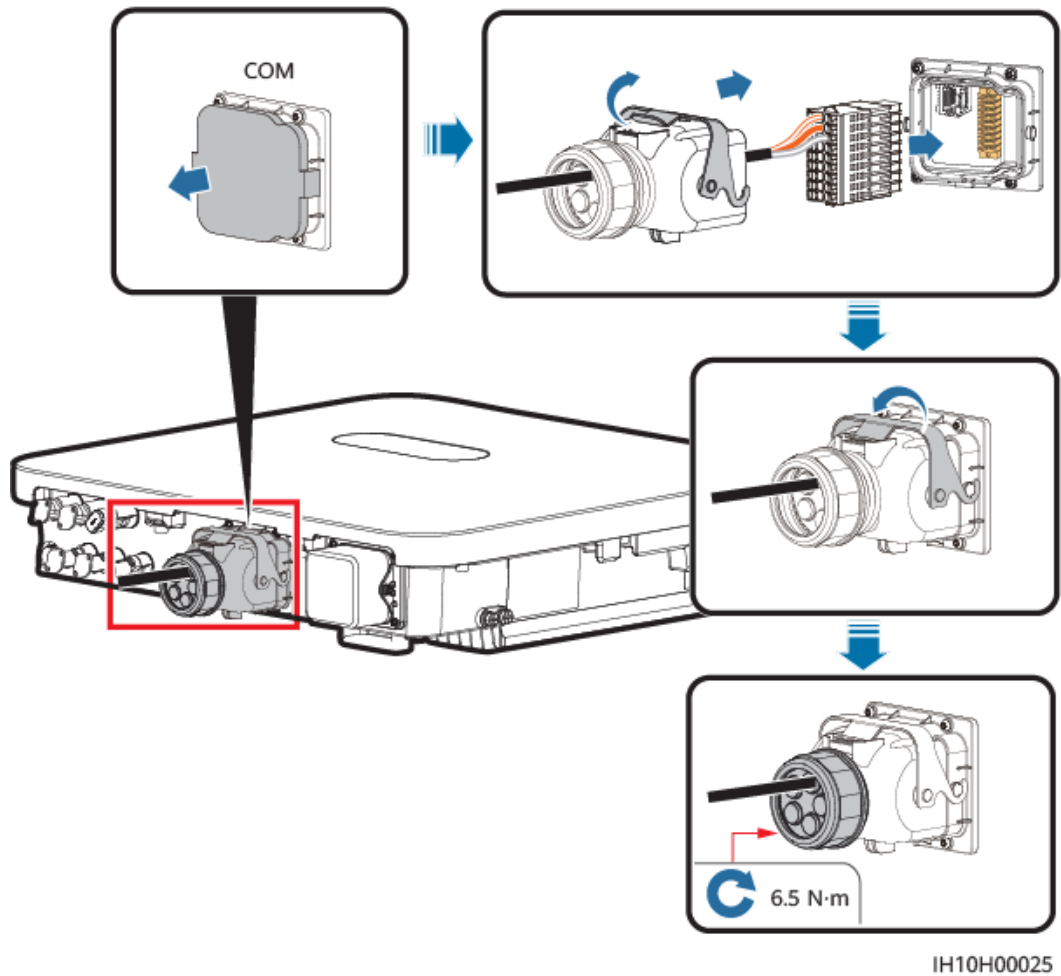
Figure 5-19 Installing the cable



IH10H00024

Step 2 Connect the signal cable connector to the COM port.

Figure 5-20 Securing the signal cable connector



----End

5.7.2 Connecting RS485 Communications Cables (Power Meter)

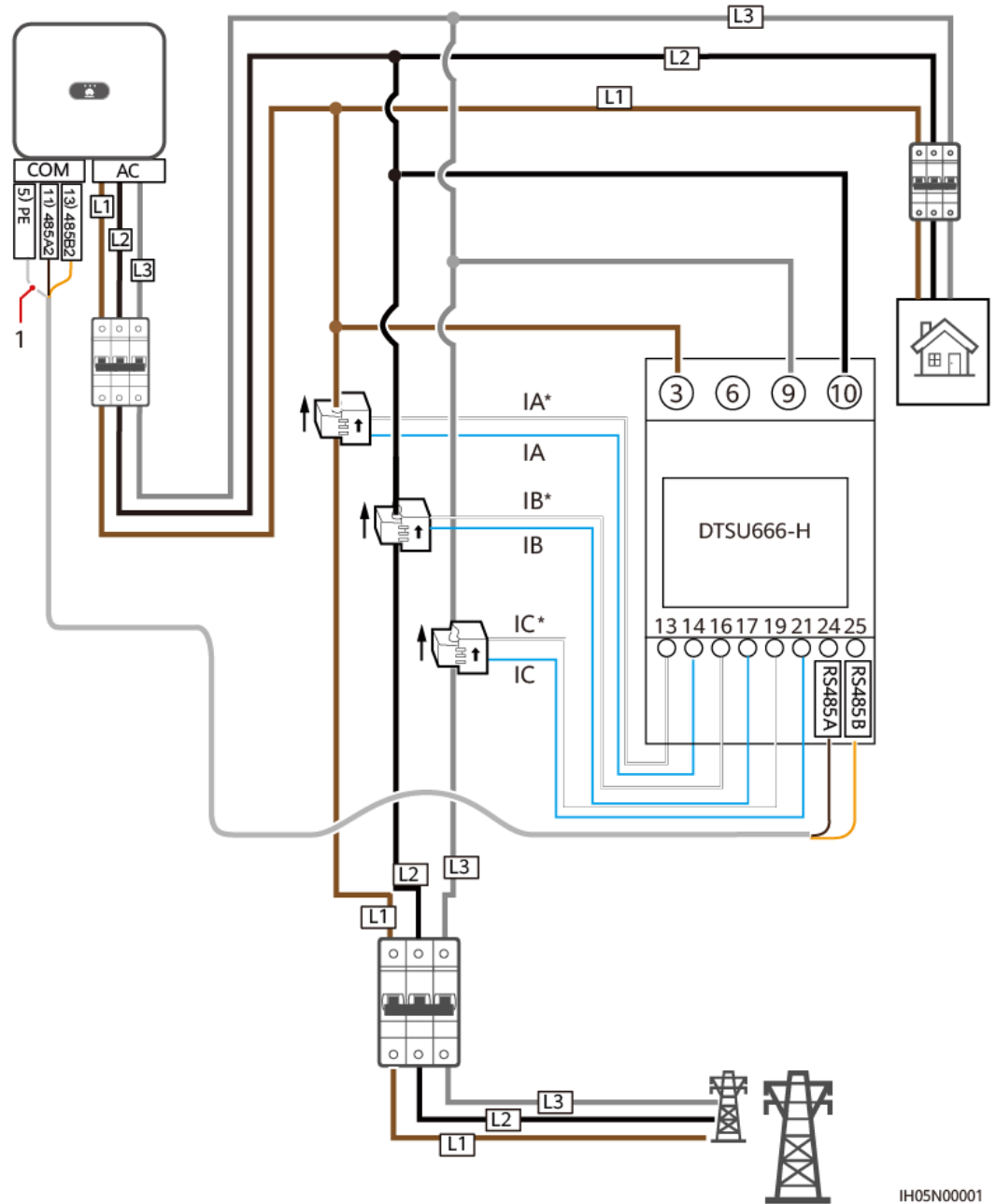
Cable Connection

The following figures show the cable connections between the inverter and DTSU666-H and YDS60-C24 power meters.

NOTE

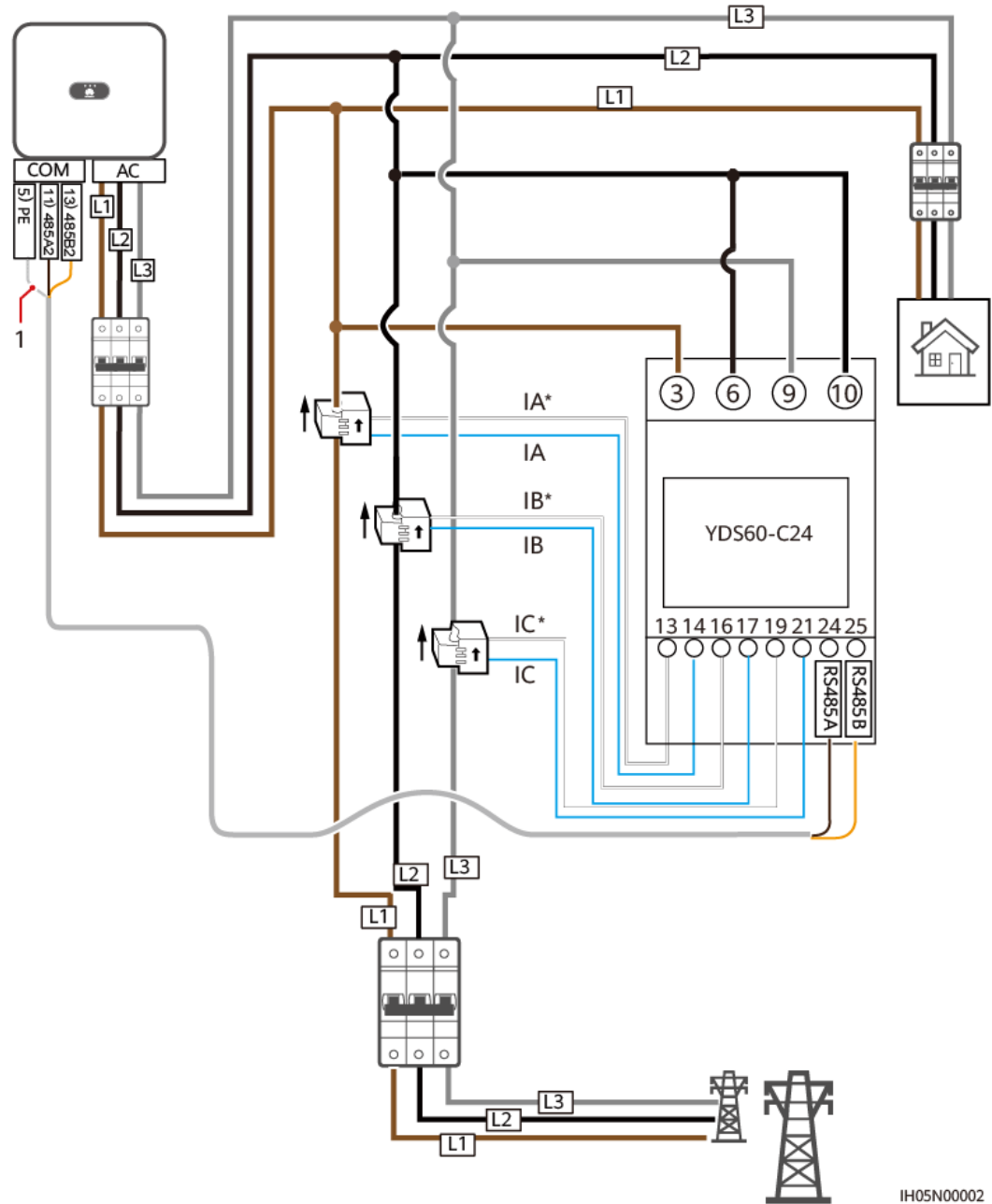
The cable connections between the DTSU71 or DHSU1079-CT power meter and the inverter are the same as those between the DTSU666-H power meter and the inverter.

Figure 5-21 DTSU666-H three-phase, three-wire cable connection (Smart Dongle networking)



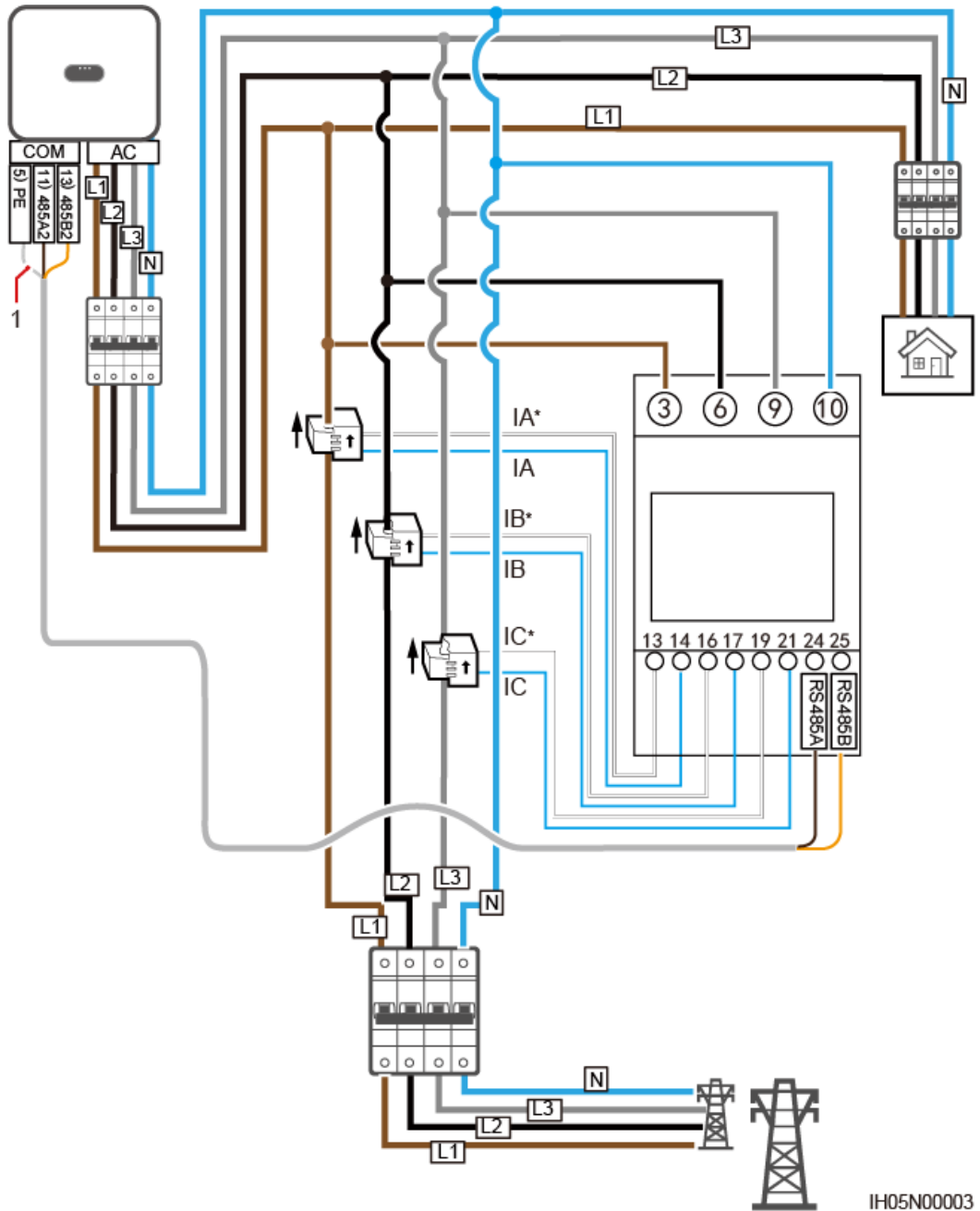
IH05N00001

Figure 5-22 YDS60-C24 three-phase, three-wire cable connection (Smart Dongle networking)



IH05N00002

Figure 5-23 Three-phase, four-wire connection (Smart Dongle networking)



IH05N00003

(1) Shield layer of the signal cable

NOTE

For three-phase, three-wire connection, set the cable connection mode. Otherwise, the voltage reading is incorrect.

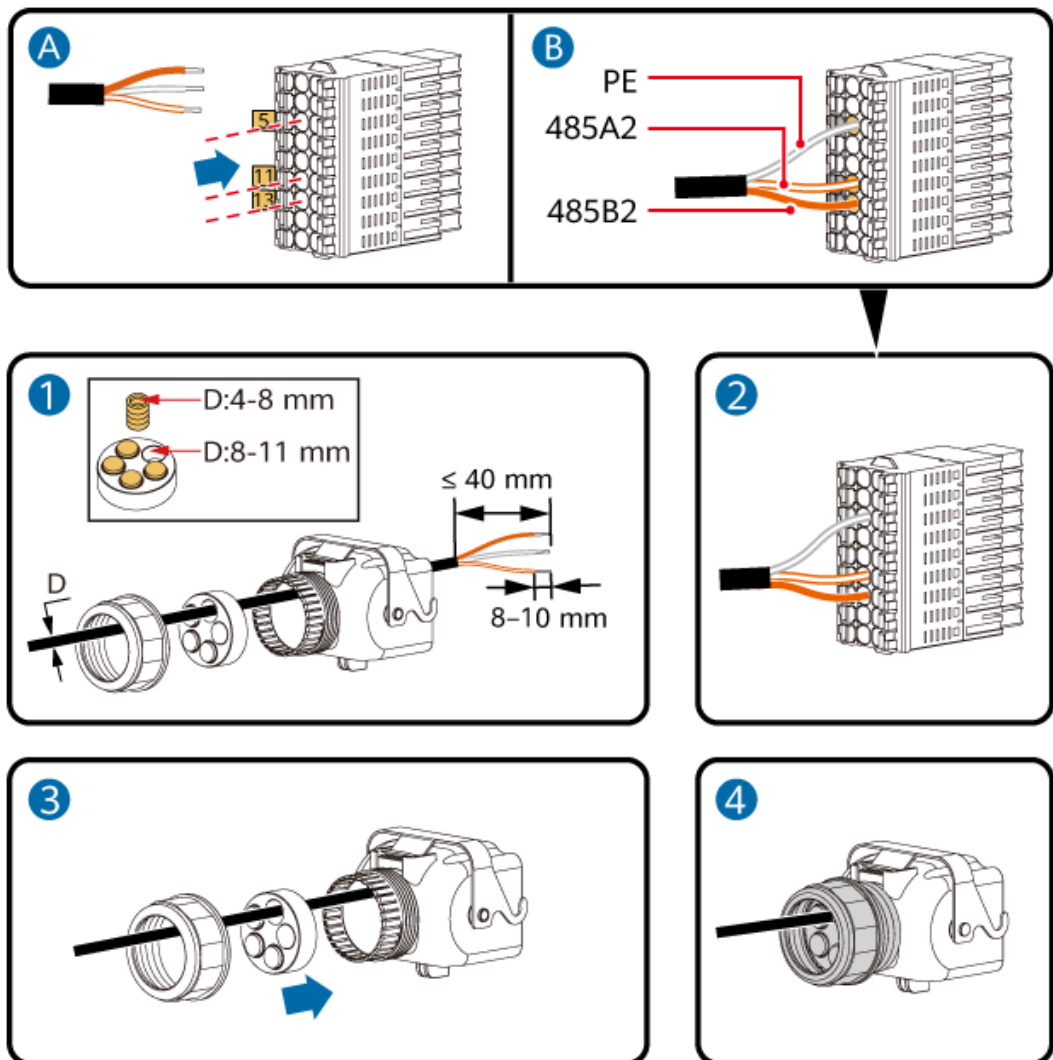
Table 5-3 Setting the cable connection mode

Parameter	Description
nE _t	Set the cable connection mode. 0 : n.34 indicates three-phase, four-wire (factory default). 1 : n.33 indicates three-phase, three-wire.

Procedure

Step 1 Connect the signal cable to the signal cable terminal.

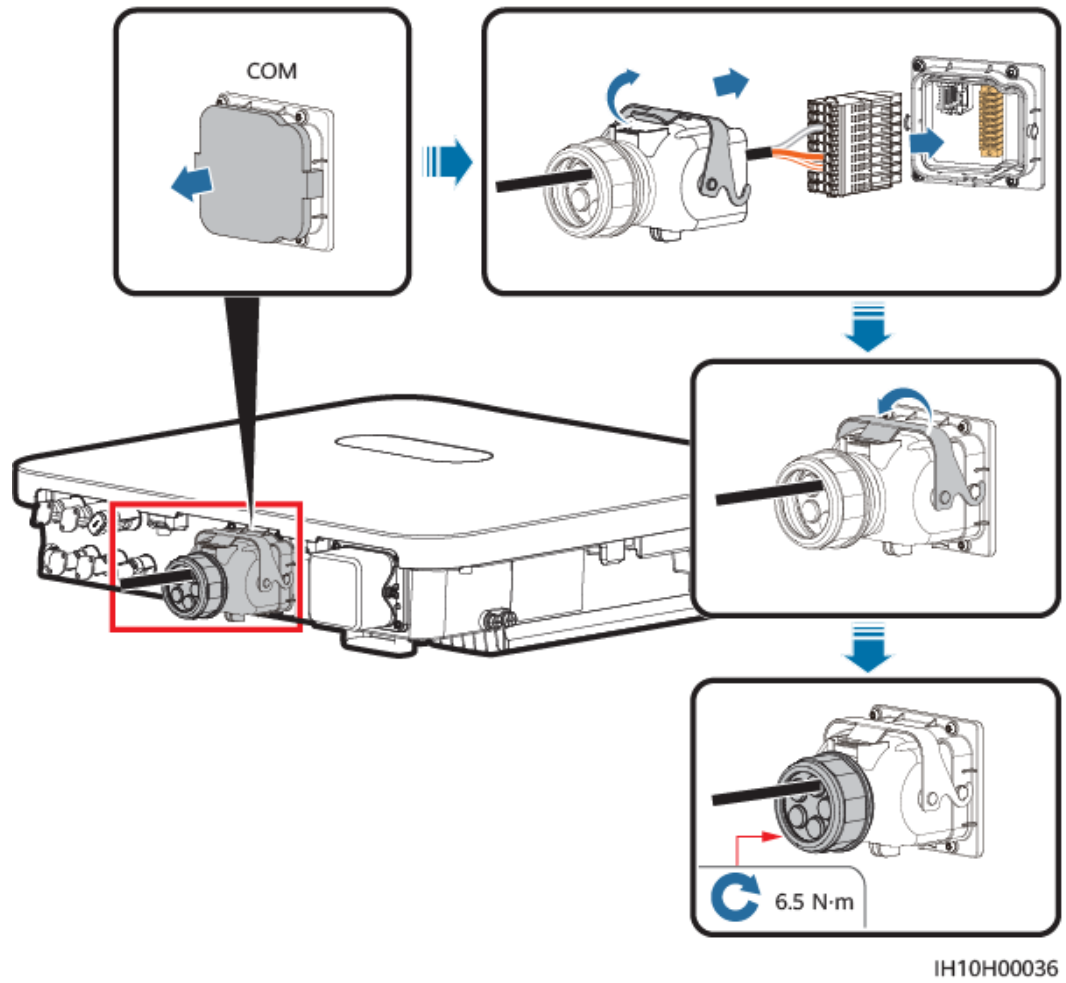
Figure 5-24 Installing the cable



IH10H00027

Step 2 Connect the signal cable connector to the COM port.

Figure 5-25 Securing the signal cable connector



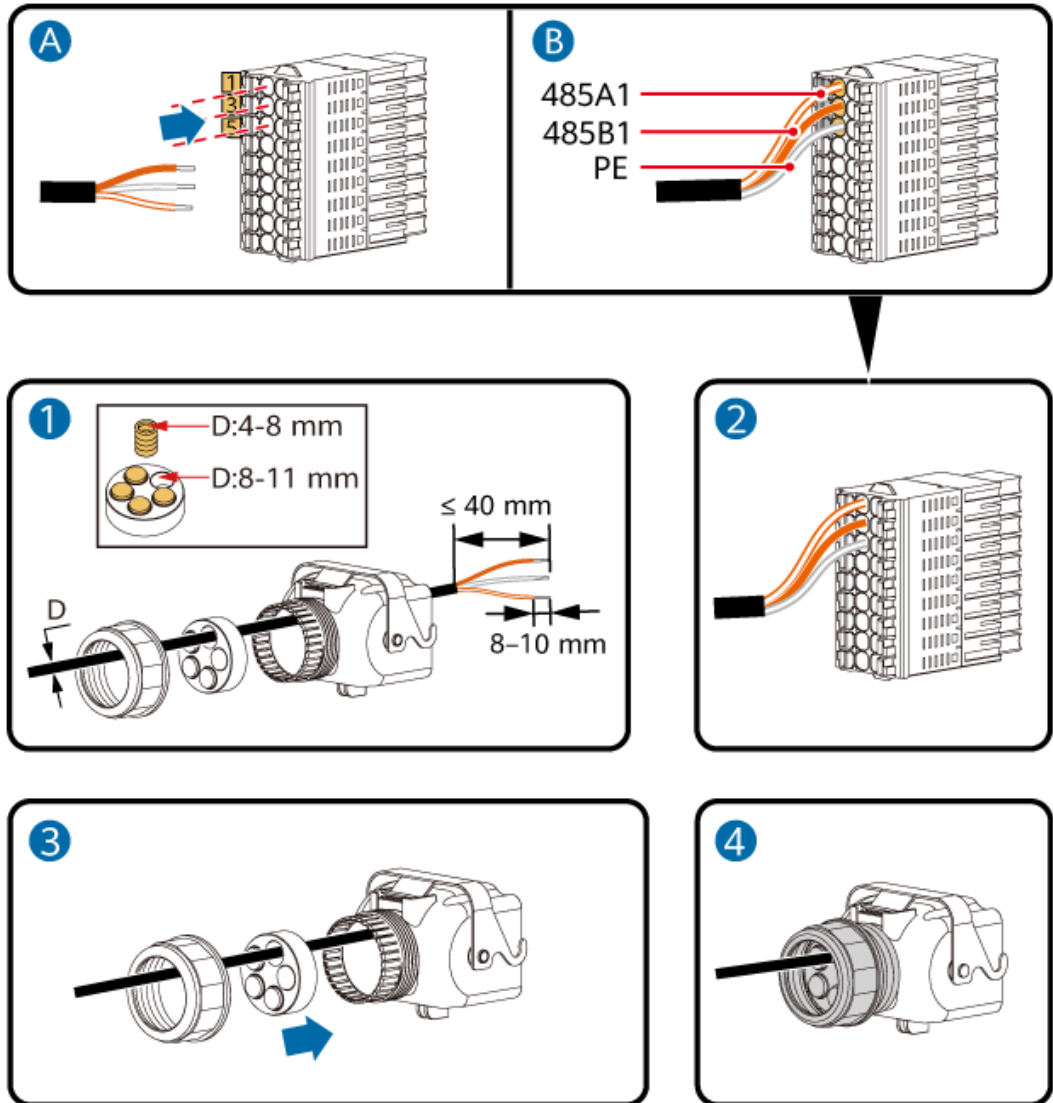
----End

5.7.3 Connecting RS485 Communications Cables (EMMA)

Procedure

Step 1 Connect the signal cable to the signal cable terminal.

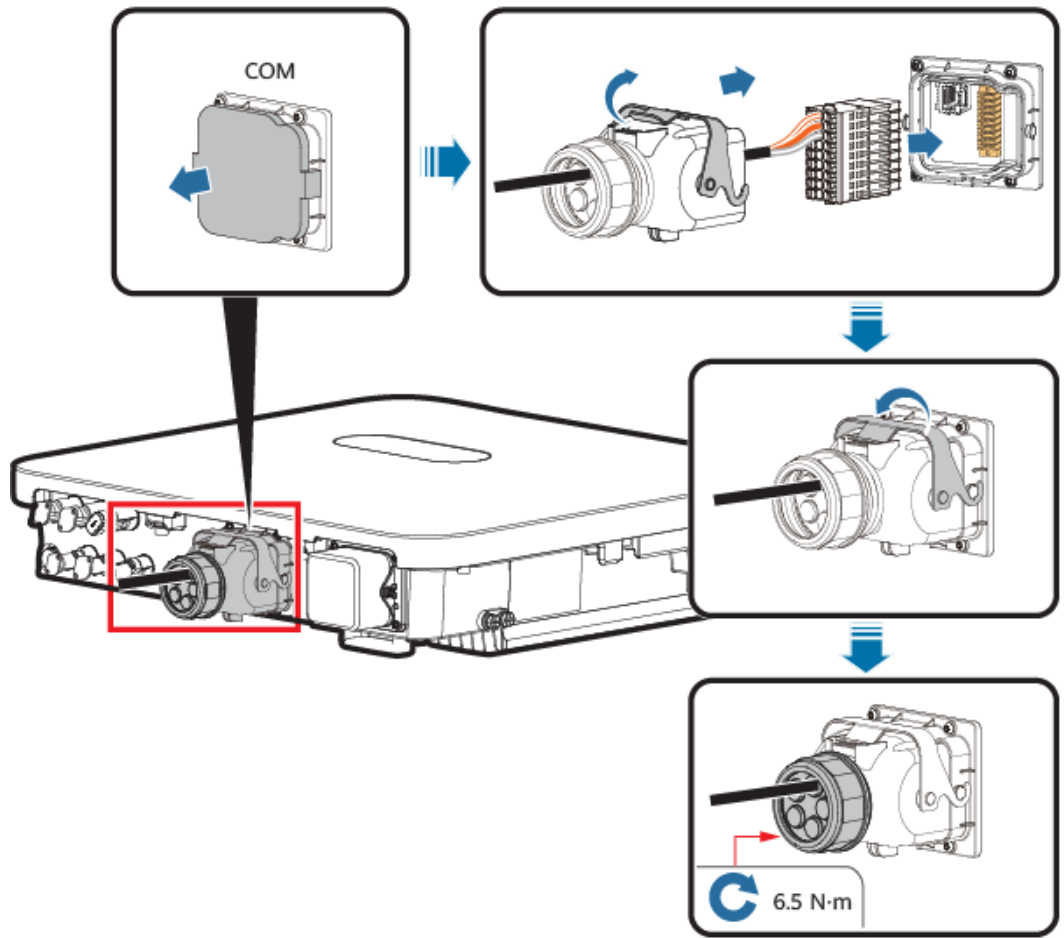
Figure 5-26 Installing the cable



IH10H00029

Step 2 Connect the signal cable connector to the COM port.

Figure 5-27 Securing the signal cable connector



IH10H00037

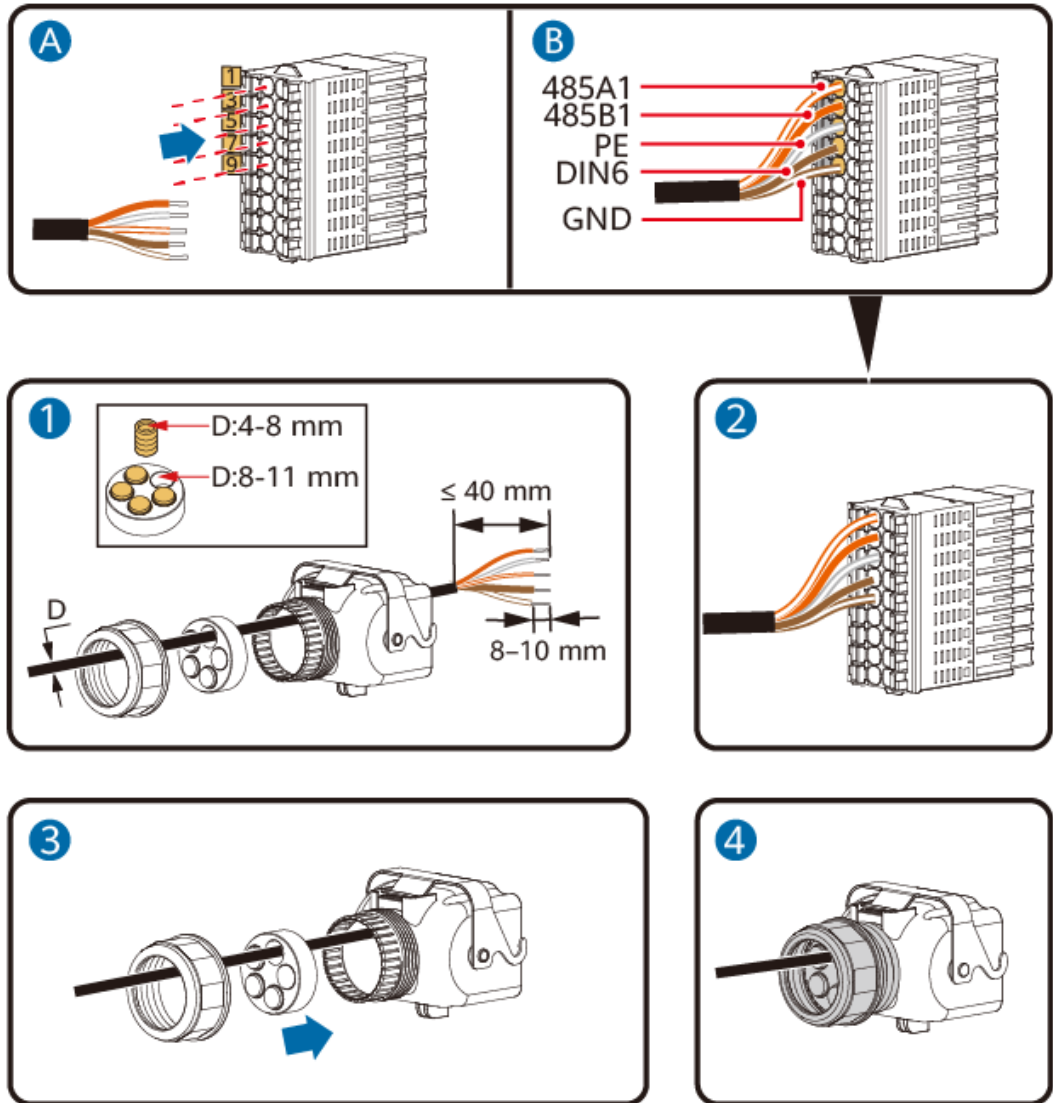
----End

5.7.4 Connecting RS485 Communications Cables (SmartGuard)

Procedure

Step 1 Connect the signal cable to the signal cable terminal.

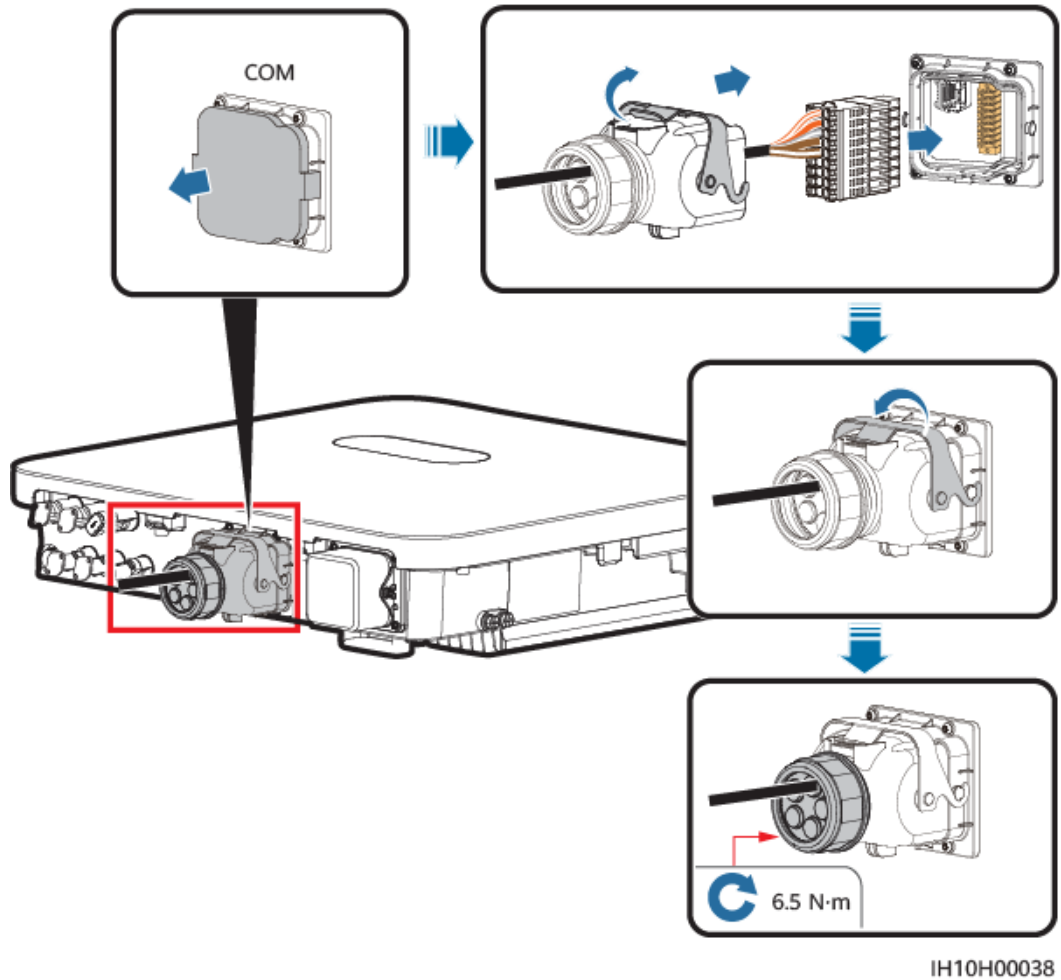
Figure 5-28 Installing the cable



IH10H00034

Step 2 Connect the signal cable connector to the COM port.

Figure 5-29 Securing the signal cable connector

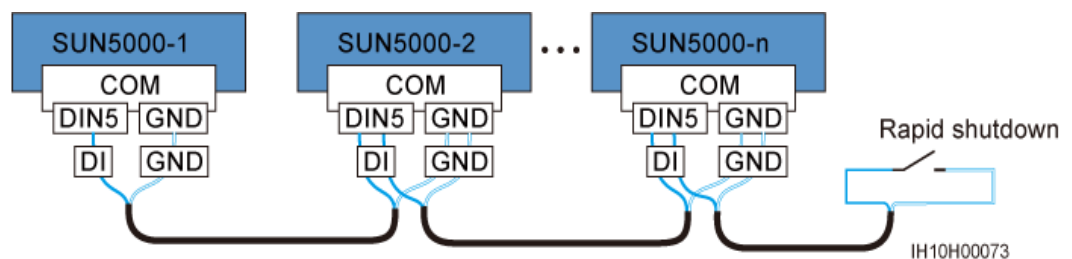


----End

5.7.5 Connecting the Rapid Shutdown Signal Cable

Cable Connections

Figure 5-30 Connecting cascaded inverters to the rapid shutdown switch



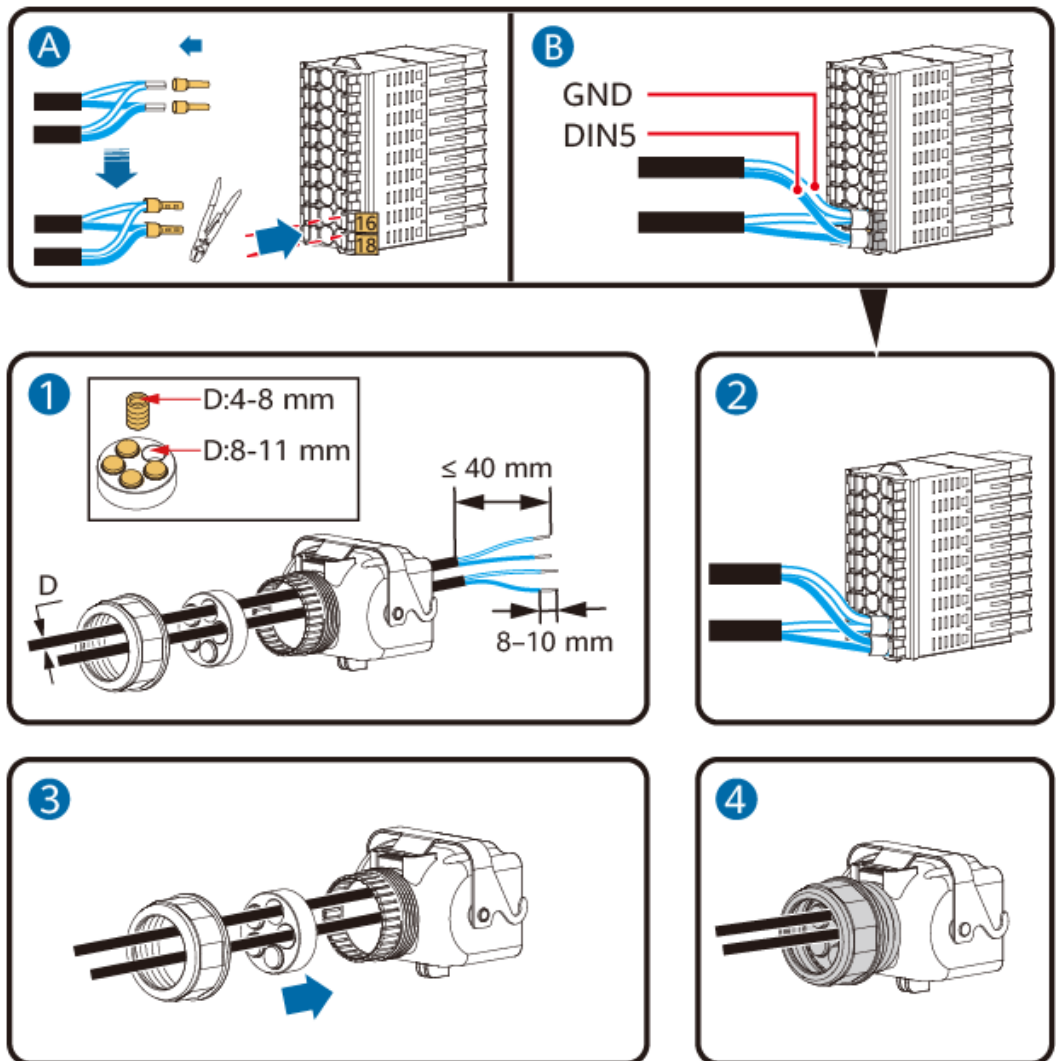
Procedure

Step 1 Connect the signal cable to the signal cable connector.

NOTICE

- The rapid shutdown function is supported only if optimizers are configured for all PV modules.
- To use the rapid shutdown function, connect terminals 16 and 18 to a switch. The switch is turned on by default. When the switch is turned off, a rapid shutdown is triggered.

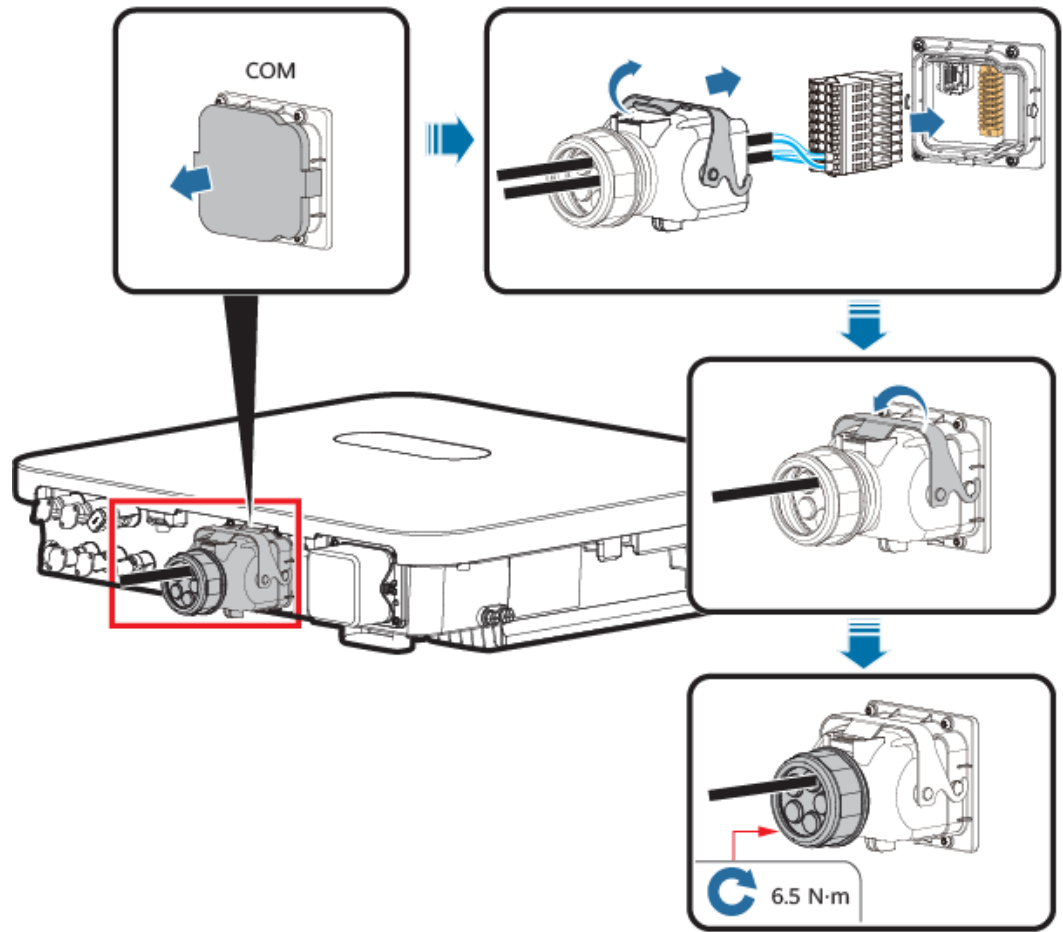
Figure 5-31 Installing the cable



IH10H00035

Step 2 Connect the signal cable connector to the COM port.

Figure 5-32 Securing the signal cable connector



IH10H00044

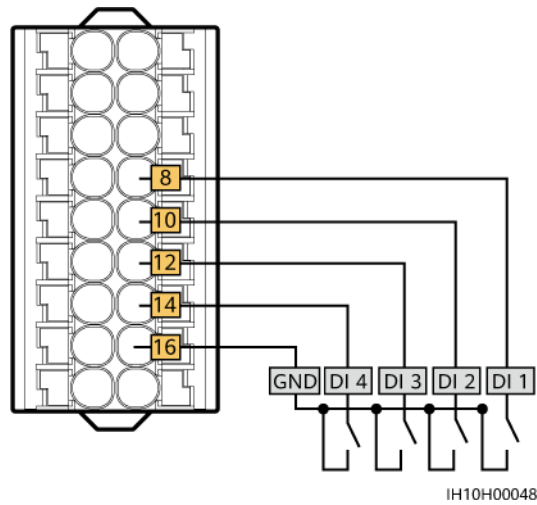
----End

5.7.6 Connecting the Grid Scheduling Signal Cable

Cable Connection

The following figure shows the cable connection between the inverter and the ripple control device.

Figure 5-33 Cable connection



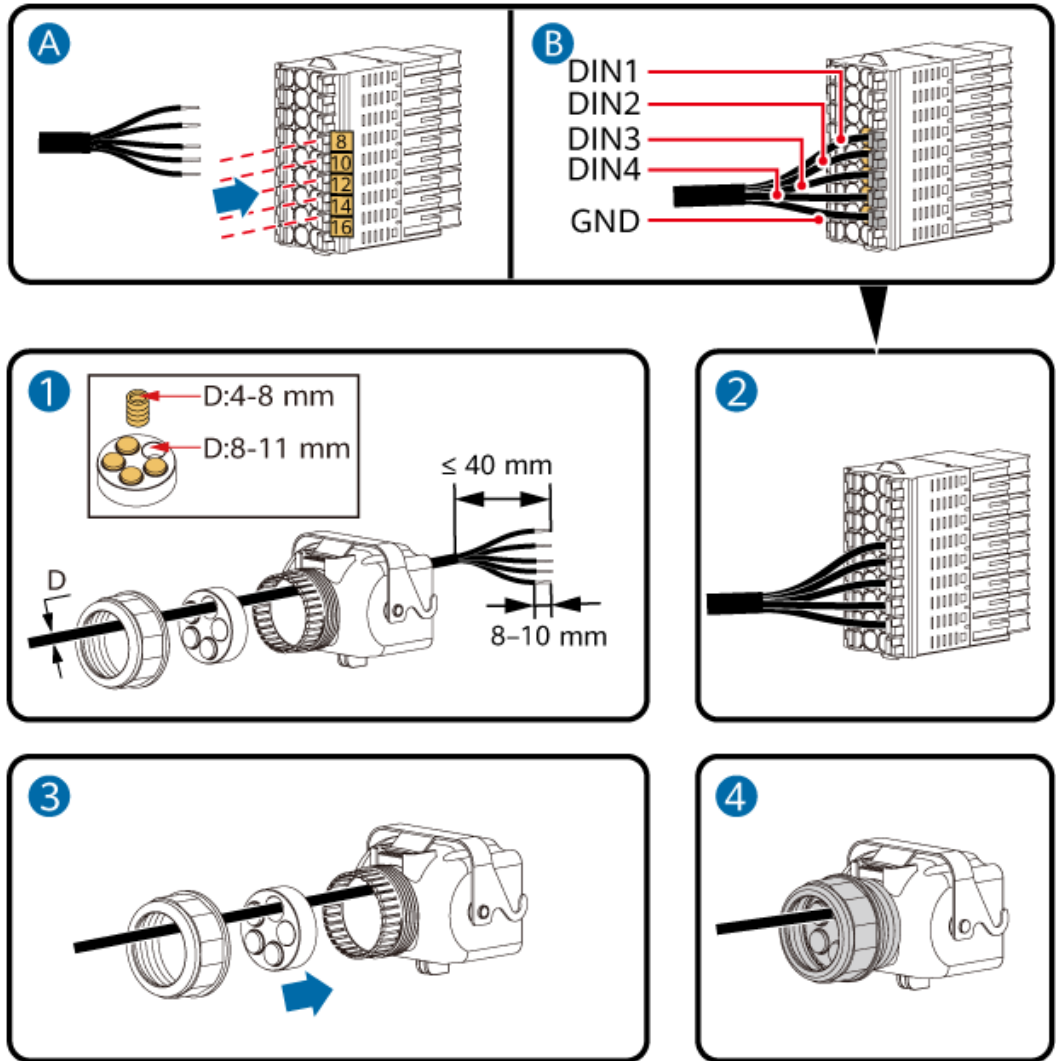
NOTICE

- In EMMA networking, ensure that **Dry contact scheduling** is disabled for the inverter. Otherwise, the inverter may not accept power scheduling instructions from the EMMA.
- If **Dry contact scheduling** is enabled for the inverter by mistake, choose **Settings > Power adjustment > Dry contact scheduling** on the home screen of the app to disable **Dry contact scheduling**.

Procedure

- Step 1** Connect the signal cable to the signal cable connector.

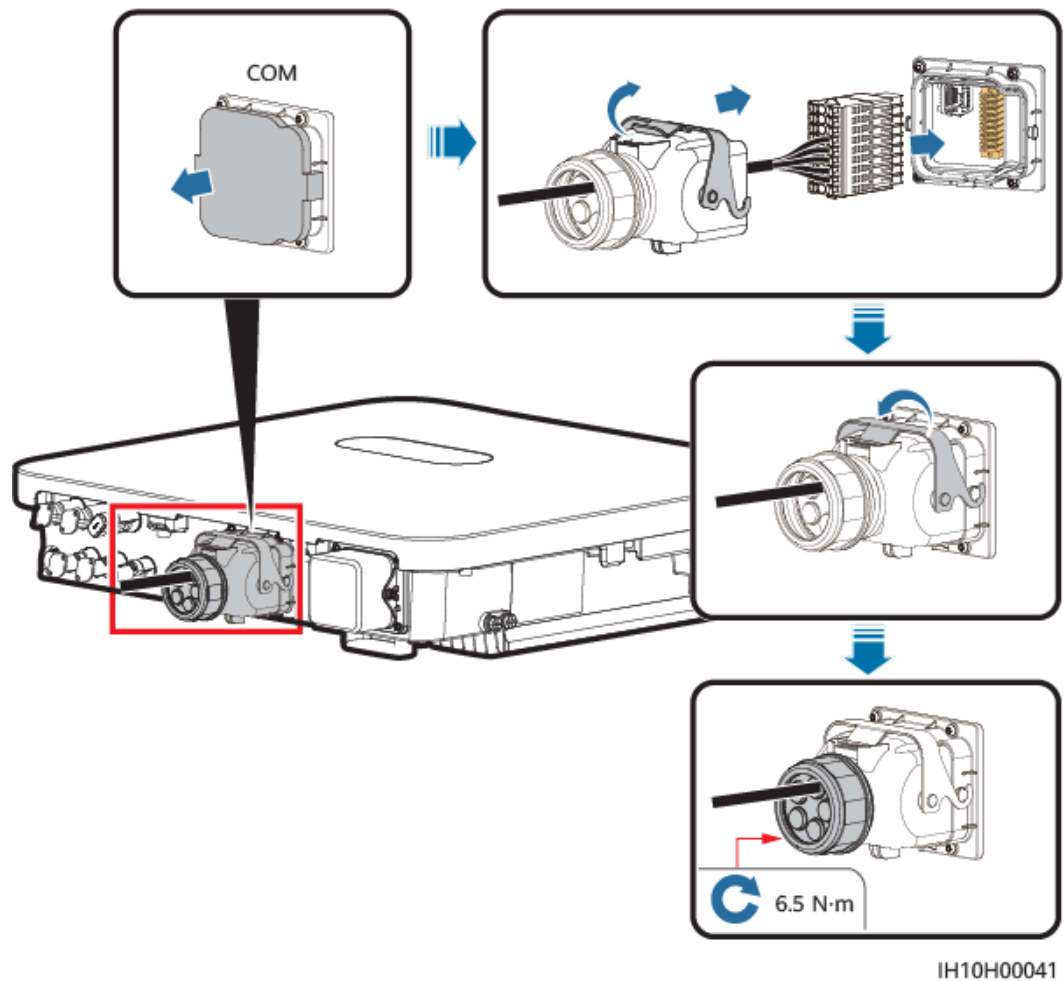
Figure 5-34 Installing the cable



IH10H00040

Step 2 Connect the signal cable connector to the COM port.

Figure 5-35 Securing the signal cable connector



----End

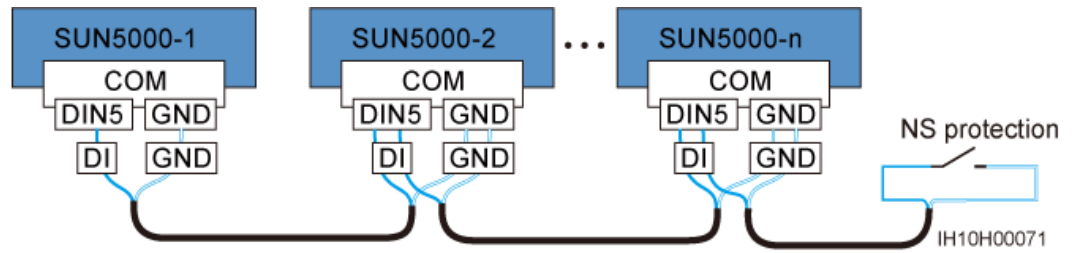
5.7.7 Connecting NS Protection Signal Cables

Connecting NS Protection Signal Cables to Inverters

NOTE

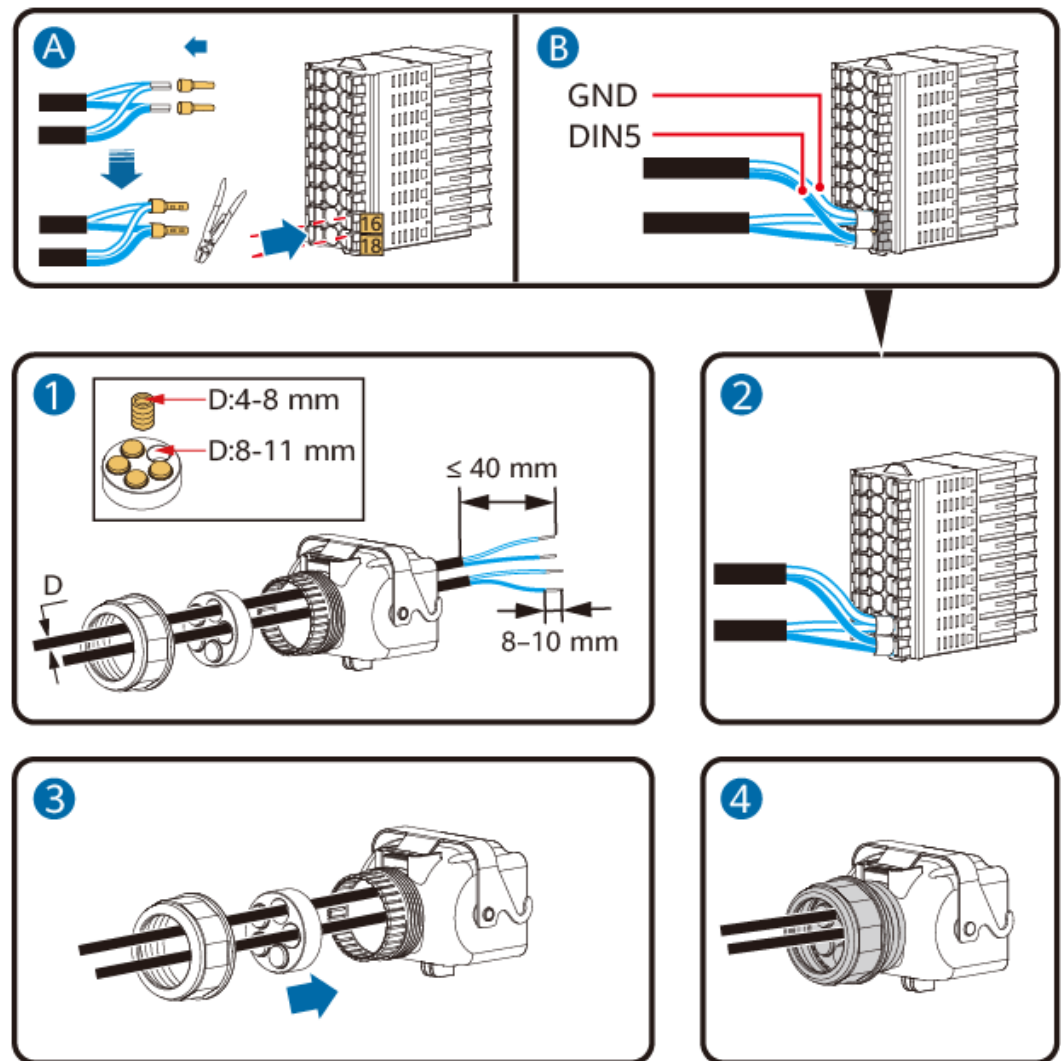
- The NS protection function is applicable to grid code **VDE-AR-N-4105**, **SWITZERLAND-NA/EEA:2020-LV230**, **EN50549-FI**, or **ANRE**.
- Connect the NS protection switch to GND (pin 16) and DIN5 (pin 18). The switch is turned on by default. When the switch is turned off, NS protection is triggered. Rapid shutdown and NS protection use the same pins, which are GND (pin 16) and DIN5 (pin 18). Therefore, you can use only either of the functions.
- The cable connection method for a single inverter is the same as that for cascaded inverters. For a single inverter, connect GND and DIN5 to the same cable.
- Log in to the FusionSolar app as an installer, choose **Me > Device commissioning**, and connect to the WLAN hotspot of the inverter. Log in to the local commissioning system as an installer, choose **Settings > Feature parameters > Dry contact function**, and set **Dry contact function** to **NS protection**.

Figure 5-36 Connecting cascaded inverters to the NS protection switch



Step 1 Connect signal cables to the signal cable connector (for inverter cascading).

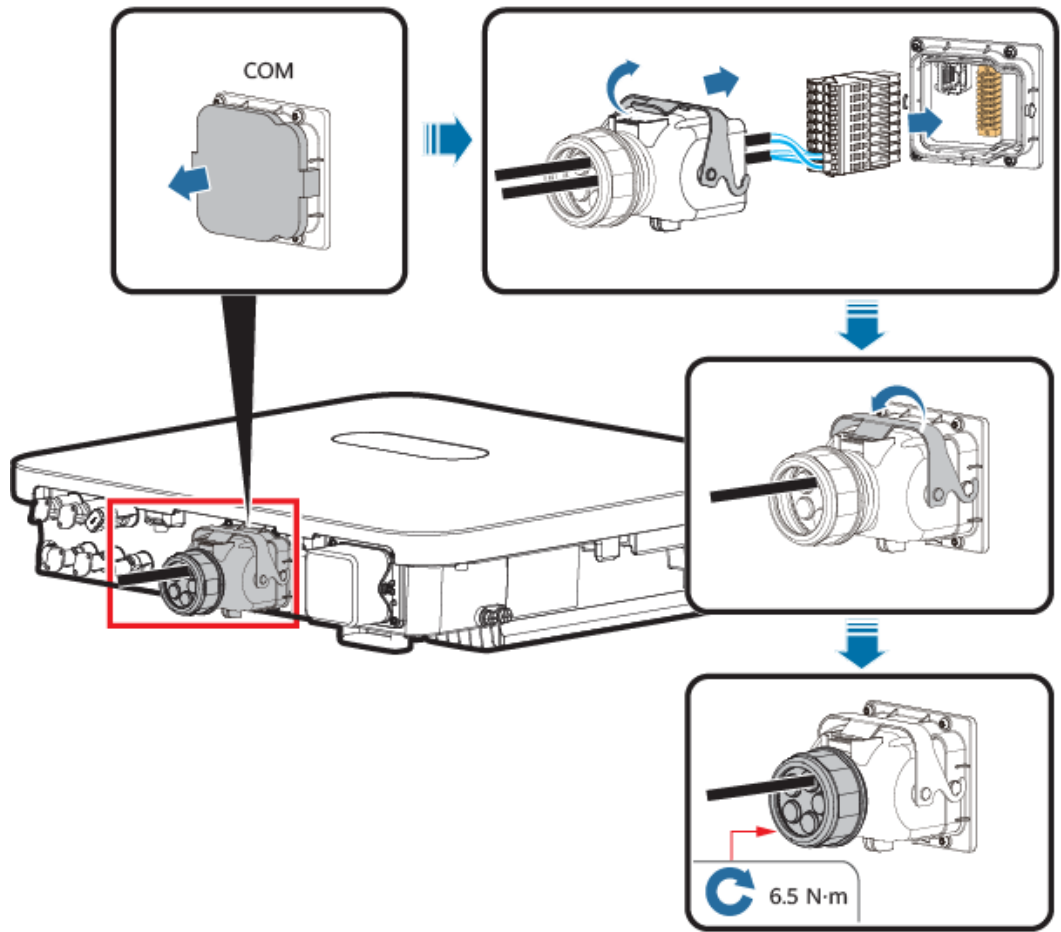
Figure 5-37 Installing cables



IH10H00043

Step 2 Connect the signal cable connector to the COM port.

Figure 5-38 Securing the signal cable connector



IH10H00044

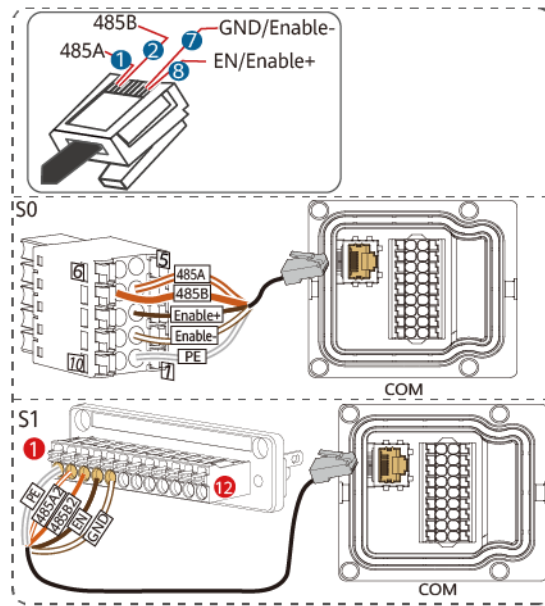
----End

5.7.8 Connecting the Battery Signal Cable

Cable Connection

The following figure shows the cable connection between the inverter and the battery.

Figure 5-39 Cable connection



IH10H00042

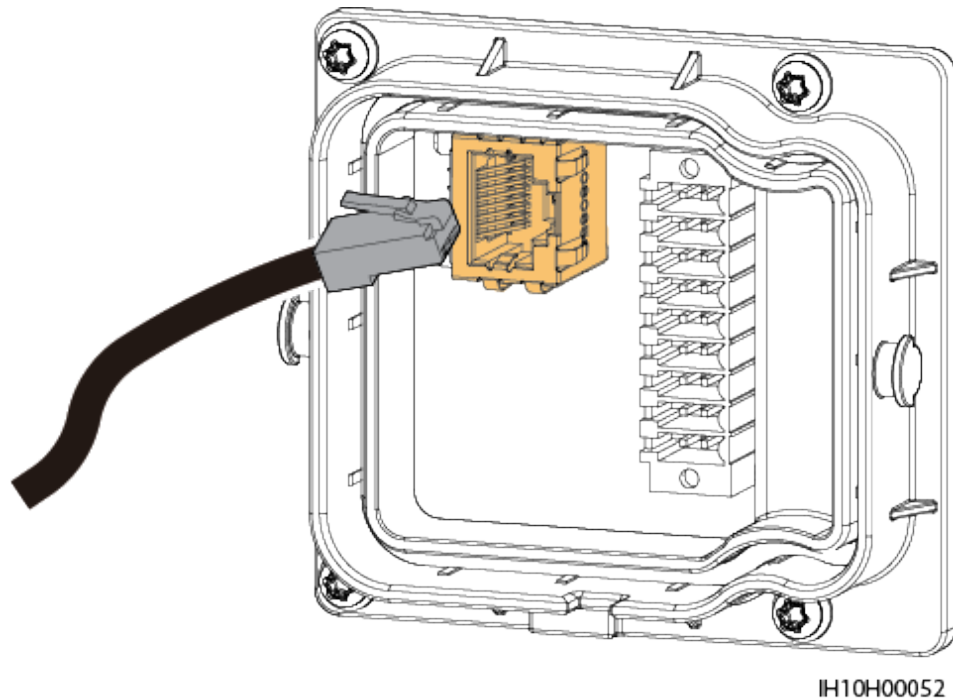
Table 5-4 Cable connection description

RJ45	Cable Color	Definition
1	White-and-orange	485A
2	Orange	485B
3	White-and-green	-
4	Blue	-
5	White-and-blue	-
6	Green	-
7	White and brown	GND/Enable-
8	Brown	EN/Enable+

Procedure

Step 1 Connect the RJ45 connector of the battery signal cable to the RJ45 port.

Figure 5-40 Installing the cable



----End

5.8 (Optional) Installing the Smart Dongle and Anti-theft Components

NOTE

- If WLAN-FE communication is used, install the WLAN-FE Smart Dongle (SDongleA-05). For details, see [SDongleA-05 Smart Dongle Quick Guide \(WLAN-FE\)](#).
- If 4G communication is used, install the 4G Smart Dongle (SDongleB-06). For details, see [SDongleB-06 Smart Dongle Quick Guide \(4G\)](#).
- If the Smart Dongle is used, you need to install anti-theft components after installing the Smart Dongle.

WLAN-FE Smart Dongle (FE Communication)

You are advised to use a CAT 5E outdoor shielded network cable (outer diameter < 9 mm; internal resistance ≤ 1.5 ohms/10 m) and shielded RJ45 connectors.

Figure 5-41 Installing the WLAN-FE Smart Dongle (FE communication)

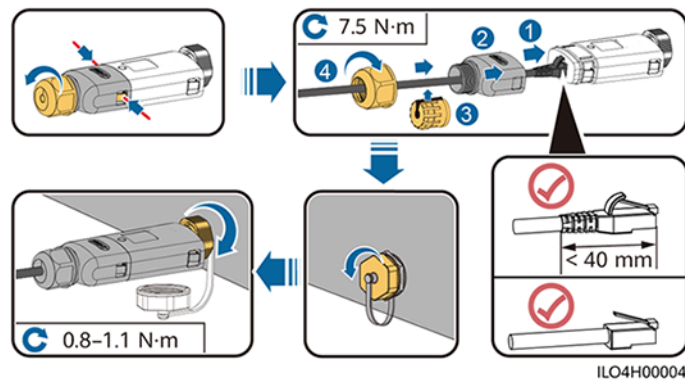
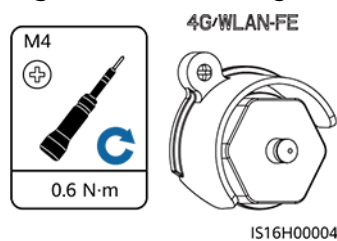


Figure 5-42 Installing anti-theft components for the Smart Dongle



4G Smart Dongle (4G Communication)

NOTE

- If your Smart Dongle is not configured with a SIM card, you need to prepare one (dimensions: 25 mm x 15 mm; capacity: ≥ 64 KB).
- When installing the SIM card, determine its installation direction based on the silk screen and arrow on the card slot.
- Press the SIM card in place to lock it. In this case, the SIM card is correctly installed.
- When removing the SIM card, push it inward to eject it.
- When reinstalling the enclosure of the Smart Dongle, ensure that the snap-fits click into place.

Figure 5-43 Installing the 4G Smart Dongle (SDongleB-06)

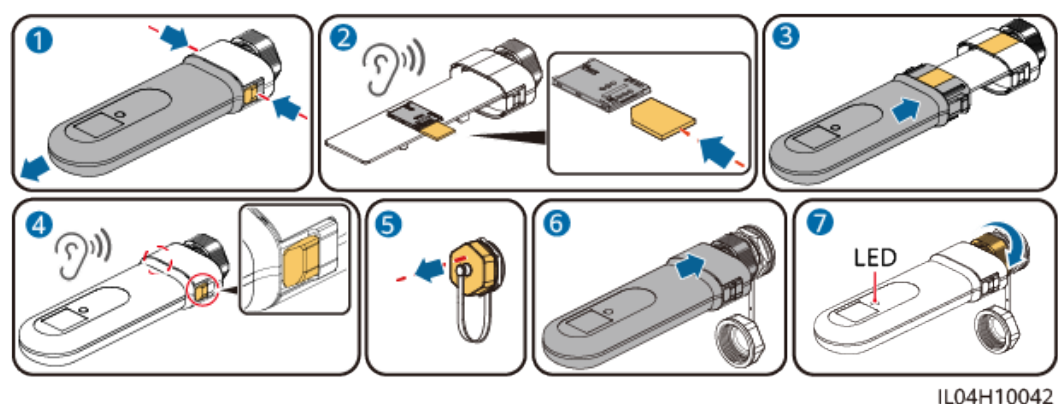
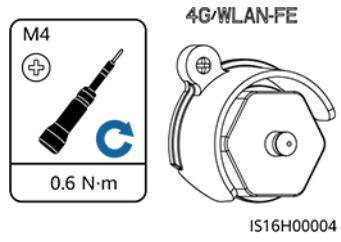


Figure 5-44 Installing anti-theft components for the Smart Dongle



6 Check Before Power-On

Table 6-1 Checklist

No.	Check Item	Expected Result
1	Inverter	The inverter is installed correctly and securely.
2	Smart Dongle	The Smart Dongle is installed correctly and securely.
3	Cable routing	Cables are routed properly as required by the customer.
4	Cable ties	Cable ties are evenly distributed and no burr exists.
5	Grounding	The PE cable is connected correctly, securely, and reliably.
6	Switches	All DC SWITCH and other switches connected to the inverter are turned off.
7	Cable connections	The AC output power cable, DC input power cables, and signal cables are connected correctly and securely.
8	Unused terminals and ports	Unused terminals and ports are locked by waterproof glands.
9	Installation environment	The installation space is proper, and the installation environment is clean and tidy.

7 Power-On and Commissioning

DANGER

- Wear personal protective equipment and use dedicated insulated tools to avoid electric shocks or short circuits.
-

7.1 Powering On the Inverter

Precautions

NOTICE

- Before the equipment is put into operation for the first time, ensure that the parameters are set correctly by professional personnel. Incorrect parameter settings may result in noncompliance with local grid connection requirements and affect the normal operations of the equipment.
 - If the DC power supply is connected but the AC power supply is disconnected, the inverter will report a **Grid Failure** alarm. The inverter can start properly only after the power grid recovers.
-

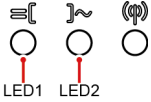
Procedure

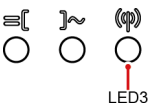
- Step 1** If a battery is connected, turn on the battery switch first.
- Step 2** At the AC switch between the inverter and the power grid, use a multimeter to measure the grid voltage and ensure that the voltage is within the allowed operating voltage range of the inverter. If the voltage is not in the allowed range, check the circuits.
- Step 3** Turn on the AC switch between the inverter and the power grid.
- Step 4** Turn on the DC switch (if any) between the PV strings and the inverter.
- Step 5** (Optional) Remove the DC switch padlock from the inverter.

Step 6 Set the DC SWITCH on the inverter to ON.

Step 7 Observe the LED indicators to check the status of the inverter.

Table 7-1 LED indicator description

Category	Status		Description
Running indication 	LED1	LED2	-
	Steady green	Steady green	The inverter is operating in grid-tied mode.
	Blinking green slowly (on for 1s and off for 1s)	Off	The DC is on and the AC is off.
	Blinking green slowly (on for 1s and off for 1s)	Blinking green slowly (on for 1s and off for 1s)	Both the DC and AC are on, and the inverter is off-grid.
	Off	Blinking green slowly (on for 1s and off for 1s)	The DC is off and the AC is on.
	Steady yellow	Steady yellow	The inverter is running in off-grid state.
	Blinking yellow slowly	Off	The DC is on and the inverter has no output in off-grid state.
	Blinking yellow slowly	Blinking yellow slowly	The inverter is overloaded in off-grid state.
	Off	Off	Both the DC and AC are off.
	Blinking red fast (on for 0.2s and off for 0.2s)	-	There is a DC environmental alarm, such as High String Input Voltage , String Reverse Connection , or Low Insulation Resistance .

Category	Status			Description
	-	Blinking red fast		There is an AC environmental alarm, such as Grid Undervoltage, Grid Overvoltage, Grid Overfrequency, or Grid Underfrequency.
	Steady red	Steady red		A fault exists.
Communica tion indication 	LED3			-
	Blinking green fast (on for 0.2s and off for 0.2s)		Communication is in progress. (When a mobile phone is connected to the inverter, the indicator first blinks green slowly, indicating that the phone is connected to the inverter.)	
	Blinking green slowly (on for 1s and off for 1s)		The mobile phone is connected to the inverter.	
	Off		There is no communication.	
Device replacement indication	LED1	LED2	LED3	-
	Steady red	Steady red	Steady red	The inverter hardware is faulty and needs to be replaced.

Step 8 (Optional) Observe the Smart Dongle LED indicator to check the status of the Smart Dongle.

- WLAN-FE Smart Dongle

Figure 7-1 WLAN-FE Smart Dongle

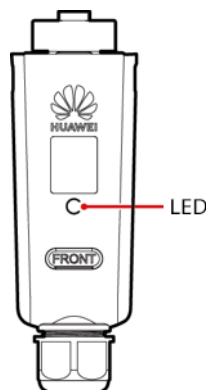


Table 7-2 Indicator description

LED Indicator	Status	Remarks	Description
-	Off	Normal	The Smart Dongle is not secured or not powered on.
Yellow (blinking green and red simultaneously)	Steady on		The Smart Dongle is secured and powered on.
Red	Blinking fast (on for 0.2s and off for 0.2s)		The parameters for connecting to the router are to be set.
Red	Steady on	Abnormal	The Smart Dongle is faulty and needs to be replaced.
Blinking red and green alternately	Blinking slowly (on for 1s and off for 1s)	Abnormal	No communication with the inverter: <ul style="list-style-type: none"> - Remove and then insert the Smart Dongle. - Check whether the inverter matches the Smart Dongle. - Connect the Smart Dongle to another inverter. Check whether the Smart Dongle is faulty or the USB port of the inverter is faulty.
Green	Blinking slowly (on for 0.5s and off for 0.5s)	Normal	Connecting to the router
Green	Steady on		The management system is successfully connected.
Green	Blinking fast (on for 0.2s and off for 0.2s)		The inverter is communicating with the management system through the Smart Dongle.

- 4G Smart Dongle

Table 7-3 Indicator description

LED Indicator	Status	Remarks	Description
-	Off	Normal	The Smart Dongle is not secured or not powered on.
Yellow (blinking green and red simultaneously)	Steady on	Normal	The Smart Dongle is secured and powered on.
Green	The blinking interval is 2s. The indicator is on for 0.1s and off for 1.9s.	Normal	Dialing (lasts for less than 1 minute)
		Abnormal	If the duration is longer than 1 minute, the 4G parameter settings are incorrect. Re-configure the parameters.
	Blinking slowly (on for 1s and off for 1s)	Normal	The dialup is successful (lasts for less than 30s).
		Abnormal	If the duration is longer than 30s, the management system parameters are incorrectly set. Re-configure the parameters.
	Steady on	Normal	The management system is successfully connected.
Blinking fast (on for 0.2s and off for 0.2s)	The inverter is communicating with the management system through the Smart Dongle.		
Red	Steady on	Abnormal	The Smart Dongle is faulty and needs to be replaced.
	Blinking fast (on for 0.2s and off for 0.2s)		The Smart Dongle has no SIM card or the SIM card is in poor contact. Check whether the SIM card has been installed or is in good contact. If not, install a SIM card or remove and re-insert the SIM card.

LED Indicator	Status	Remarks	Description
	Blinking slowly (on for 1s and off for 1s)		The Smart Dongle fails to be connected to a management system because the SIM card has poor or no reception, or has run out of mobile data. If the Smart Dongle is reliably connected, check the SIM card connectivity through the app. If you have poor or no reception, contact the carrier. Check whether the tariff and mobile data plan of the SIM card are adequate. If not, ensure sufficient balance in the SIM card or purchase a data package.
Blinking red and green alternately	Blinking slowly (on for 1s and off for 1s)		No communication with the inverter: <ul style="list-style-type: none"> - Remove and then insert the Smart Dongle. - Check whether the inverter matches the Smart Dongle. - Connect the Smart Dongle to another inverter. Check whether the Smart Dongle is faulty or the USB port of the inverter is faulty.

----End

7.2 Commissioning the Inverter (Smart Dongle Networking)

NOTICE

- The grid-connection voltage and frequency of an inverter in China Region are set before delivery according to NB/T 32004 or the latest Chinese standard. If the inverter fails to connect to the power grid because the power grid voltage is close to or higher than the voltage required by Chinese laws and regulations, you can select another voltage level based on the voltage at the grid connection point after obtaining permission from the local power operator.
- If the power grid voltage exceeds the upper threshold, the service life of loads on the grid connection side may be affected, or energy yield loss may occur. In this case, the Company will not be liable for any consequences.

7.2.1 Deploying a New Plant

Figure 7-2 Deploying a new plant

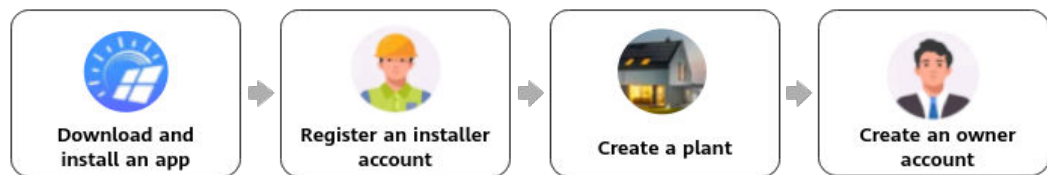


Table 7-4 Plant deployment description

No.	Task	Description
1	Downloading and installing an app	Download and install the FusionSolar app.
2	Registering an installer account	Register an installer account required for deployment and commissioning.
3	Creating a plant	Access the Setup wizard screen, scan the QR code to create a plant, commission devices according to the quick setting process, and connect devices to the plant.
4	Creating an owner account	Create an owner account that can be used to remotely monitor and manage devices.

For details, see [FusionSolar App Quick Guide](#). Scan the QR code of the inverter to create a plant.

7.2.2 Setting Common Parameters

Set common parameters based on the devices connected to the plant.

Table 7-5 Setting common parameters

Function	Scenario Description	Operation
Grid-tied point control	Many regions impose a limit on the feed-in power of a power generation system. Therefore, a power meter is required to measure the power at the grid connection point to control the output of the inverter in real time, ensuring that the feed-in power meets the power requirement allowed by the power grid.	For details, see section "Parameter Settings" in the Residential Smart PV Solution User Manual (Smart Dongle Networking & Inverter Direct Connection) .
Battery parameter setting	If a battery is connected to the system, you need to add the battery and set battery parameters.	
Peak shaving	Applies to areas that have peak demand charges. The peak shaving function allows you to lower the peak power drawn from the grid in maximum self-consumption or TOU mode during peak hours, reducing electricity fees.	
Setting the physical layout of optimizers	If optimizers are configured for PV modules, you can view the physical location of each optimizer after creating a physical layout. If a PV module is faulty, you can quickly locate the faulty PV module from the physical layout to rectify the fault. If a PV module without an optimizer is faulty, you need to check the PV modules one by one to locate the faulty one, which is time-consuming and inefficient.	

For details about how to set more parameters, see [FusionSolar App and SUN2000 App Device Commissioning Guide](#).

7.2.3 AFCI

Function Description

If PV modules or cables are incorrectly connected or damaged, electric arcs may be generated, which may cause fire. Huawei inverters provide unique arc fault detection in compliance with UL 1699B-2018 to safeguard users' lives and protect their property.

This function is enabled by default. The inverter automatically detects arc faults. To disable this function, log in to the FusionSolar app, choose **Services > Device Commissioning**, connect to the inverter WLAN as prompted, log in to the device, choose **Set > Feature parameters** on the home screen, and disable **AFCI**.

NOTE

The AFCI function works only with Huawei optimizers or ordinary PV modules when the inverter is connected to the grid, but does not support third-party optimizers or intelligent PV modules.

Clearing Alarms

The AFCI function involves the **DC arc fault** alarm.

The inverter has the AFCI alarm automatic clearance mechanism. If the alarm is triggered for less than five times within 24 hours, the inverter automatically clears the alarm. If the alarm is triggered for five times or more within 24 hours, the inverter locks for protection. You need to manually clear the alarm on the FusionSolar app or FusionSolar SmartPVMS so that it can work properly. You can manually clear the alarm in either of the following ways:

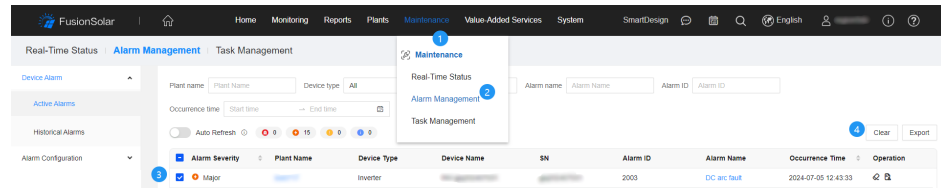
- **Method 1:** FusionSolar app
 - a. **Connect to the inverter that has generated the AFCI alarm using the app** and log in to the local commissioning screen of the device as an installer.
 - b. Tap **Alarm**. On the **Current Alarms** screen, tap **Clear** on the right of the **DC arc fault** alarm to clear the alarm.

Figure 7-3 Clearing the alarm



- **Method 2:** FusionSolar SmartPVMS
 - a. Log in to the FusionSolar SmartPVMS using an installer account, choose **Maintenance > Alarm Management**, select the **DC arc fault** alarm, and click **Clear**.

Figure 7-4 Clearing the alarms



- b. Log in the FusionSolar SmartPVMS as a plant owner. Click the plant name on the **Home** page to access the plant page, and clear the alarm as prompted.

7.2.4 IPS Test (Italy CEI0-21)

Function Description

The Italy CEI0-21 grid code requires that an inverter implements an IPS test. During the test, the inverter continuously detects the protection thresholds and protection time thresholds of **Maximum voltage over 10 min (59.S1)**, **Maximum voltage (59.S2)**, **Minimum voltage (27.S1)**, **Minimum voltage (27.S2)**, **Maximum frequency (81 > S1)**, **Maximum frequency (81 > S2)**, **Minimum frequency (81 < S1)**, and **Minimum frequency (81 < S2)**.

Procedure

Step 1 Perform operations by referring to [Connecting to the Inverter on the App](#) and choose **Maintenance > IPS test** on the home screen.

Step 2 Tap **Start** to start the test.

The inverter simultaneously detects eight parameters **Maximum voltage over 10 min (59.S1)**, **Maximum voltage (59.S2)**, **Minimum voltage (27.S1)**, **Minimum voltage (27.S2)**, **Maximum frequency (81 > S1)**, **Maximum frequency (81 > S2)**, **Minimum frequency (81 < S1)**, and **Minimum frequency (81 < S2)**.

Figure 7-5 IPS test

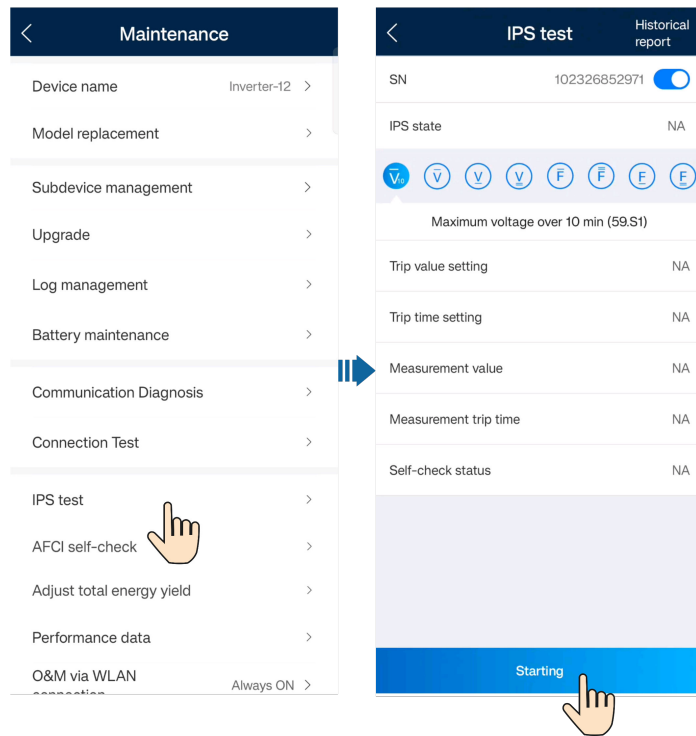


Table 7-6 IPS test types

IPS Test Type	Description
Maximum voltage over 10 min (59.S1)	The default overvoltage voltage over 10 min protection threshold is 253 V (1.10 Vn), and the default protection time threshold is 3s.
Maximum voltage (59.S2)	The default overvoltage protection threshold is 264.5 V (1.15 Vn), and the default protection time threshold is 0.2s.
Minimum voltage (27.S1)	The default undervoltage protection threshold is 195.5 V (0.85 Vn), and the default protection time threshold is 1.5s.
Minimum voltage (27.S2)	The default undervoltage protection threshold is 34.5 V (0.15 Vn), and the default protection time threshold is 0.2s.
Maximum frequency (81 > S1)	The default overfrequency protection threshold is 50.2 Hz, and the default protection time threshold is 0.1s.
Maximum frequency (81 > S2)	The default overfrequency protection threshold is 51.5 Hz, and the default protection time threshold is 0.1s.
Minimum frequency (81 < S1)	The default underfrequency protection threshold is 49.8 Hz, and the default protection time threshold is 0.1s.

IPS Test Type	Description
Minimum frequency (81 < S2)	The default underfrequency protection threshold is 47.5 Hz, and the default protection time threshold is 0.1s.

Step 3 After test is complete, **IPS state** is displayed as **Self-test success**. Tap **Historical report** in the upper right corner of the screen to view the **IPS test** report.

----End

7.2.5 Limit on Power Purchased from Grid

Function

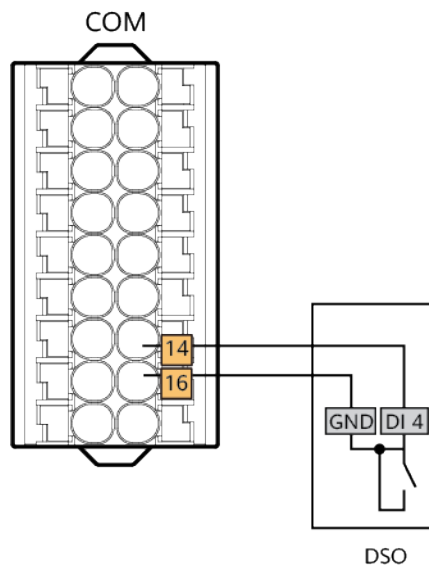
This function is used to control load power purchased from the grid. The power grid company uses the controller to transmit scheduling commands through the DI4 port. When the load power purchased from the grid is too high, it is limited. After the load capacity of the power grid recovers, the limit on the load power is removed.

NOTICE

Before setting this function, ensure that the inverter is correctly connected to the local DSO controller.

The following figure shows the cable connections between the inverter and the local DSO controller.

Figure 7-6 Cable connections



Procedure

1. [Connect to the inverter on the app](#) and log in to the local commissioning screen of the device as an installer.
2. Choose **Power adjustment > Dry contact scheduling settings** and enable **Limit on power purchased from grid**.
3. Tap **Submit**.

NOTE

- If **Dry contact scheduling** has been enabled and the DI4 port has been configured, clear the DI4 port settings before enabling **Limit on power purchased from grid**. After **Limit on power purchased from grid** is enabled, the DI4 port is used to receive scheduling commands from the DSO and cannot be used for **Dry contact scheduling** (in this case, the DI4 port is not displayed on the app).
- **ESS charge power from grid** refers to the maximum charge power of all ESSs in the current network.

7.2.6 Setting the Energy Measurement Mode

Function Description

This function is used to configure different energy measurement modes for different areas. After power meters are installed, you can configure the measurement modes to implement balanced and unbalanced measurement of energy.

NOTE

Only the SUN2000-(5KTL-12KTL)-M1, SUN2000/SUN5000-(12K-25K)-MB0, SUN2000-(5K-12K)-MAP0, and SUN5000-(8K, 12K)-MAP0 series inverters support the energy measurement mode settings.

Procedure

1. [Connect to the inverter on the app](#) and log in to the local commissioning screen of the device.
2. On the home screen, choose **Maintenance > Subdevice management > PowerMeter** and set **Energy Measurement Mode**.

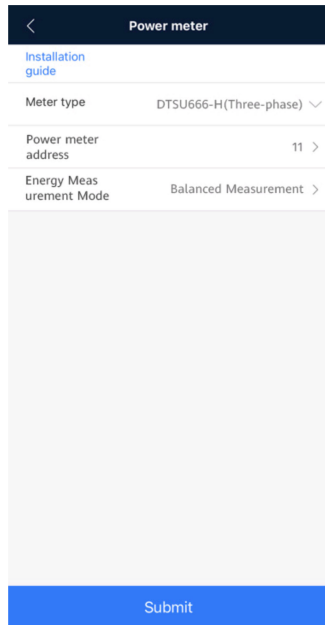


Table 7-7 Energy measurement mode

Parameter		Description
Energy Measurement Mode	Balanced Measurement	Default setting. The forward energy and reversing energy are respectively calculated by integrating the sum of power from three phases.
	Unbalanced Measurement	The forward energy and reversing energy are respectively calculated by integrating the power of each phase.

7.2.7 (Optional) Three-Phase Imbalance Control

Function Description

Three-phase imbalance control applies to the following scenarios:

- Asymmetric phase feeding with feed-in limitation: The feed-in power of each phase in the three-phase power grid cannot exceed the preset threshold. The inverter outputs different power for each phase based on the loads of each phase to ensure that the feed-in power of each phase does not exceed the preset threshold.
- PV+ESS asymmetric phase feeding for self-consumption: When the ESS discharges power to the loads, the inverter outputs phase-specific power based on the load of each phase and tracks the loads on each phase to ensure that no ESS discharge power is fed to the grid while the PV power can be fed to the grid.

The preceding two scenarios are supported concurrently.

 NOTE

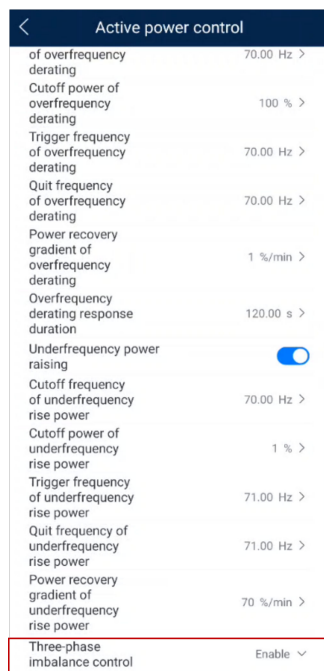
Three-phase imbalance control is not supported in the Smart Dongle networking scenario where inverters are connected in parallel.

Prerequisites

- Choose **Settings > Grid Parameters** and check that **Output mode** is set to **Three-phase, four-wire**.
- Choose **Power adjustment > Grid-tied Point Control > Active power** and check that **Closed-loop controller** is set to **Inverter** and **Limitation mode** is set to **Single phase power**.
- In the PV+ESS asymmetric phase feeding for self-consumption scenario, choose **Power adjustment > Battery control** and check that **Working Mode** is set to **Maximum self-consumption** or **TOU**.

Procedure

1. Log in to the local commissioning screen.
2. Choose **Power adjustment > Active power control** and set **Three-phase imbalance control** to **Enable**.



7.2.8 Resetting the Password for Logging In to the Local Commissioning Screen

If you forget the password for logging in to the local commissioning screen of the inverter, perform the following steps to reset the password:

Method 1: Connect to the device WLAN, obtain the verification code, and reset the password. For details, see [7.2.8.1 Resetting the Password After Connecting to the Device WLAN](#).

Method 2: Log in to the FusionSolar app, obtain the verification code, and connect to the device WLAN to reset the password. For details, see [7.2.8.2 Resetting the](#)

Password After Obtaining the Verification Code and Connecting to the Device WLAN.

NOTICE

- You can reset the login password of only one user at a time.
- This function is supported by only the inverter series of SUN2000-(3K-6K)-LB0, SUN5000-(3K,6K)-LB0, SUN2000-(8K,10K)-LC0, SUN2000-(12K-25K)-MB0, SUN5000-(17K, 25K)-MB0, SUN2000-(5K-12K)-MAP0, and SUN5000-(8K, 12K)-MAP0.

7.2.8.1 Resetting the Password After Connecting to the Device WLAN

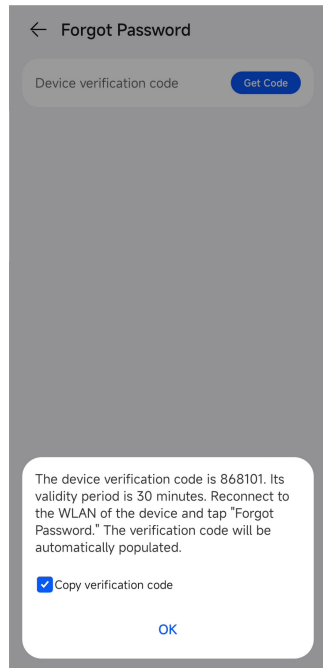
1. Log in to the FusionSolar app and choose **Services** > **Device Commissioning**.
2. **Connect to the WLAN of the inverter** and access the **Log in** screen.
3. Select the user role whose password needs to be reset and tap **Forgot password?**
4. On the **Forgot Password** screen, tap **Get Code** and switch the network as prompted.
5. Enter the FusionSolar login password to obtain the verification code. After obtaining the verification code, tap **OK** and you will be redirected to the **Forgot Password** screen.
6. Enter the verification code, tap **OK**, and set a new password on the **Log in** screen as prompted.

NOTE

After the verification code is verified, set a new password within 10 minutes.

More Guidance

If the message in the following figure is displayed, tap **OK** to return to the device connection screen, reconnect to the device WLAN, access the **Forgot Password** screen again, and enter the verification code.

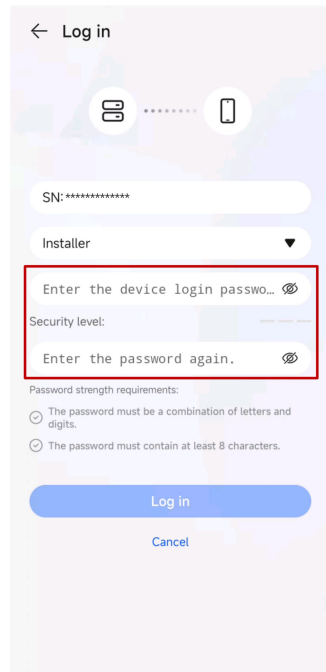


7.2.8.2 Resetting the Password After Obtaining the Verification Code and Connecting to the Device WLAN

1. Log in to the FusionSolar app and select the target plant on the home screen.
2. On the **Device** screen, choose **Inverter** > **:** > **O&M Authorization** > **Device verification code**.
3. On the **Device verification code** screen, tap **Get Code**, and enter the password for logging in to the FusionSolar to obtain a verification code.
4. Copy the verification code as prompted and tap **Proceed** to **connect to the WLAN of the inverter**.
5. On the **Log in** screen, select the user whose password needs to be reset, tap **Forgot password?**, enter the verification code, and set a new password as prompted.

NOTE

After obtaining the verification code, set a new password within 10 minutes.



7.3 Commissioning the Inverter (EMMA Networking & SmartGuard Networking)

NOTICE

- The grid-connection voltage and frequency of an inverter in China Region are set before delivery according to NB/T 32004 or the latest Chinese standard. If the inverter fails to connect to the power grid because the power grid voltage is close to or higher than the voltage required by Chinese laws and regulations, you can select another voltage level based on the voltage at the grid connection point after obtaining permission from the local power operator.
- If the power grid voltage exceeds the upper threshold, the service life of loads on the grid connection side may be affected, or energy yield loss may occur. In this case, the Company will not be liable for any consequences.

7.3.1 Deploying a New Plant

Figure 7-7 Deploying a new plant

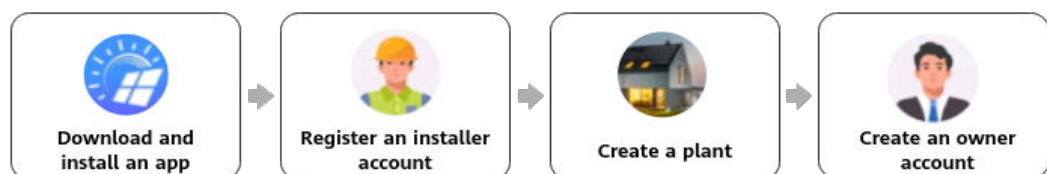


Table 7-8 Plant deployment description

No.	Task	Description
1	Downloading and installing an app	Download and install the FusionSolar app.
2	Registering an installer account	Register an installer account required for deployment and commissioning.
3	Creating a plant	Access the Setup wizard screen, scan the QR code to create a plant, commission devices according to the quick setting process, and connect devices to the plant.
4	Creating an owner account	Create an owner account that can be used to remotely monitor and manage devices.

- EMMA networking: For details, see [FusionSolar App Quick Guide \(EMMA\)](#). Scan the QR code of the EMMA to create a plant.
- SmartGuard networking: For details, see [FusionSolar App Quick Guide \(EMMA\)](#). Scan the QR code of the SmartGuard or EMMA to create a plant.

7.3.2 Setting Common Parameters

Set common parameters based on the devices connected to the plant.

Table 7-9 Setting common parameters

Function	Scenario Description	Operation
Grid-tied point control	Many regions impose a limit on the feed-in power of a power generation system. Therefore, a power meter is required to measure the power at the grid connection point to control the output of the inverter in real time, ensuring that the feed-in power meets the power requirement allowed by the power grid.	For details, see section "Parameter Settings" in the Residential Smart PV Solution User Manual (EMMA Networking & SmartGuard Networking) .
Battery parameter setting	If a battery is connected to the system, you need to add the battery and set battery parameters.	

Function	Scenario Description	Operation
Peak shaving	Applies to areas that have peak demand charges. The peak shaving function allows you to lower the peak power drawn from the grid in maximum self-consumption or TOU mode during peak hours, reducing electricity fees.	
Setting the physical layout of optimizers	If optimizers are configured for PV modules, you can view the physical location of each optimizer after creating a physical layout. If a PV module is faulty, you can quickly locate the faulty PV module from the physical layout to rectify the fault. If a PV module without an optimizer is faulty, you need to check the PV modules one by one to locate the faulty one, which is time-consuming and inefficient.	

For details about how to set more parameters, see [FusionSolar App and SUN2000 App Device Commissioning Guide](#).

7.3.3 AFCI

Function Description

If PV modules or cables are incorrectly connected or damaged, electric arcs may be generated, which may cause fire. Huawei inverters provide unique arc fault detection in compliance with UL 1699B-2018 to safeguard users' lives and protect their property.

This function is enabled by default. The inverter automatically detects arc faults. To disable this function, log in to the FusionSolar app, choose **Services > Device Commissioning**, connect to the EMMA WLAN as prompted, log in to the device, choose **Monitor** on the home screen, select the inverter, choose **Set > Feature parameters**, and disable **AFCI**.

NOTE

The AFCI function works only with Huawei optimizers or ordinary PV modules when the inverter is connected to the grid, but does not support third-party optimizers or intelligent PV modules.

Clearing Alarms

The AFCI function involves the **DC arc fault** alarm.

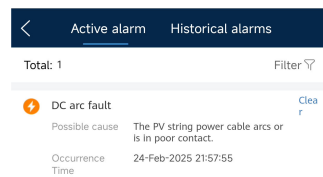
The inverter has the AFCI alarm automatic clearance mechanism. If the alarm is triggered for less than five times within 24 hours, the inverter automatically clears the alarm. If the alarm is triggered for five times or more within 24 hours, the inverter locks for protection. You need to manually clear the alarm on the FusionSolar app or FusionSolar SmartPVMS so that it can work properly. You can manually clear the alarm in either of the following ways:

- **Method 1: FusionSolar app**

Log in to the FusionSolar app, choose **Services > Device Commissioning**, connect to the EMMA, tap **Alarm** on the home screen, and tap **Clear** on the right of the **DC arc fault** alarm to clear the alarm.

- Connect to the EMMA on the app and log in to the local commissioning screen of the device as an installer.
- Tap **Alarm**. On the **Active alarm** screen, tap **Clear** on the right of the **DC arc fault** alarm to clear the alarm.

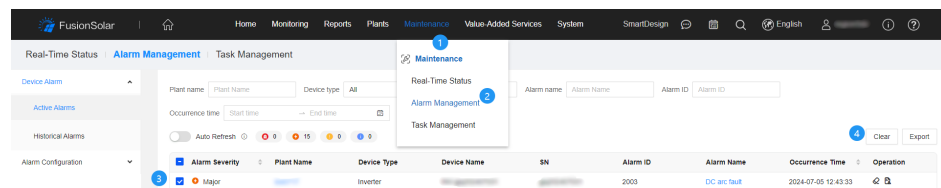
Figure 7-8 Clearing the alarm



- **Method 2: FusionSolar SmartPVMS**

- Log in to the FusionSolar SmartPVMS using an installer account, choose **Maintenance > Alarm Management**, select the **DC arc fault** alarm, and click **Clear**.

Figure 7-9 Clearing the alarms



- Log in the FusionSolar SmartPVMS as a plant owner. Click the plant name on the **Home** page to access the plant page, and clear the alarm as prompted.

7.3.4 IPS Test (Italy CEI0-21)

Function Description

The Italy CEI0-21 grid code requires that an inverter implements an IPS test. During the test, the inverter continuously detects the protection thresholds and protection time thresholds of **Maximum voltage over 10 min (59.S1)**, **Maximum voltage (59.S2)**, **Minimum voltage (27.S1)**, **Minimum voltage (27.S2)**,

Maximum frequency (81 > S1), Maximum frequency (81 > S2), Minimum frequency (81 < S1), and Minimum frequency (81 < S2).

Procedure

Step 1 Perform operations by referring to [Connecting to the Inverter on the App](#) and choose **Maintenance > IPS test** on the home screen.

Step 2 Tap **Start** to start the test.

The inverter simultaneously detects eight parameters **Maximum voltage over 10 min (59.S1), Maximum voltage (59.S2), Minimum voltage (27.S1), Minimum voltage (27.S2), Maximum frequency (81 > S1), Maximum frequency (81 > S2), Minimum frequency (81 < S1), and Minimum frequency (81 < S2).**

Figure 7-10 IPS test

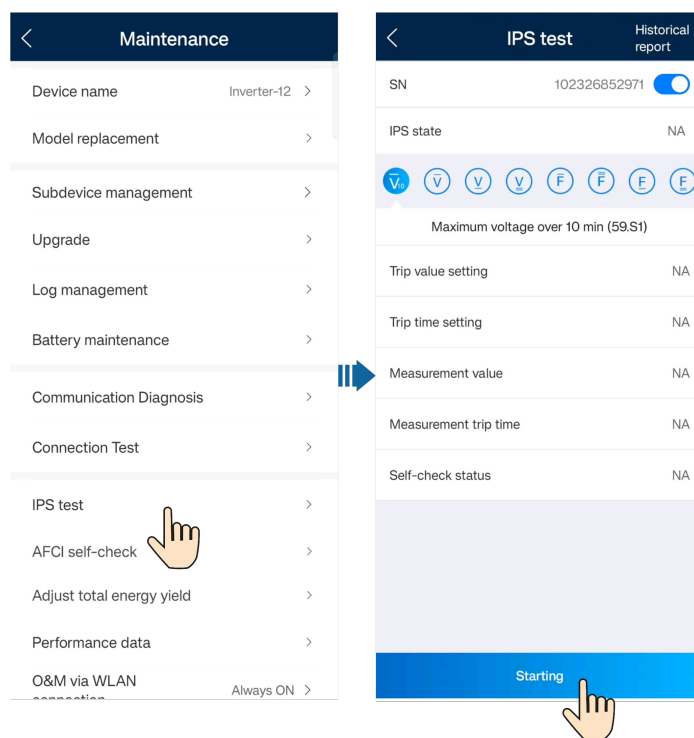


Table 7-10 IPS test types

IPS Test Type	Description
Maximum voltage over 10 min (59.S1)	The default overvoltage voltage over 10 min protection threshold is 253 V (1.10 V _n), and the default protection time threshold is 3s.
Maximum voltage (59.S2)	The default overvoltage protection threshold is 264.5 V (1.15 V _n), and the default protection time threshold is 0.2s.
Minimum voltage (27.S1)	The default undervoltage protection threshold is 195.5 V (0.85 V _n), and the default protection time threshold is 1.5s.

IPS Test Type	Description
Minimum voltage (27.S2)	The default undervoltage protection threshold is 34.5 V (0.15 Vn), and the default protection time threshold is 0.2s.
Maximum frequency (81 > S1)	The default overfrequency protection threshold is 50.2 Hz, and the default protection time threshold is 0.1s.
Maximum frequency (81 > S2)	The default overfrequency protection threshold is 51.5 Hz, and the default protection time threshold is 0.1s.
Minimum frequency (81 < S1)	The default underfrequency protection threshold is 49.8 Hz, and the default protection time threshold is 0.1s.
Minimum frequency (81 < S2)	The default underfrequency protection threshold is 47.5 Hz, and the default protection time threshold is 0.1s.

Step 3 After test is complete, **IPS state** is displayed as **Self-test success**. Tap **Historical report** in the upper right corner of the screen to view the **IPS test** report.

----End

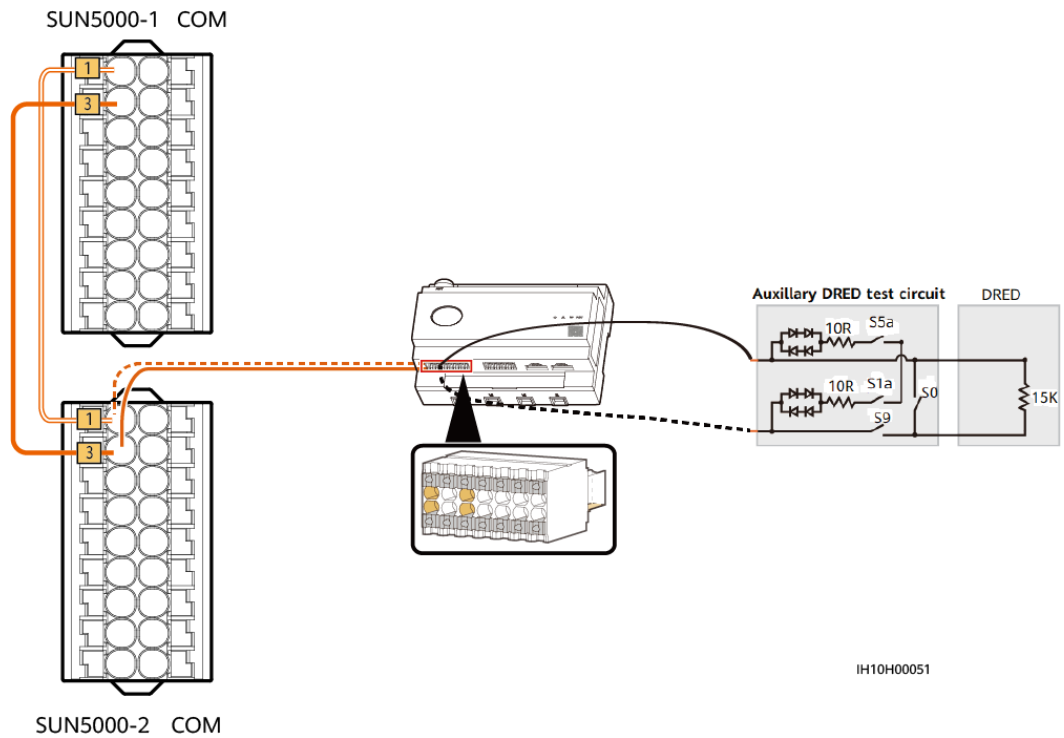
7.3.5 DRM (Australia AS 4777)

Function

According to Australia AS 4777.2-2015, inverters need to support the function of demand response modes (DRM), and DRM0 is a mandatory requirement.

This function is disabled by default.

Figure 7-11 Wiring diagram for the DRM function (EMMA networking)



NOTE

The demand response enabling device (DRED) is a power grid dispatch device.

Table 7-11 DRM requirements

Mode	Corresponding Port on the EMMA	Requirements
DRM0	DI1+ and DI1- of the COM port	<ul style="list-style-type: none"> When S0 and S9 are switched on, the inverter should be shut down. When S0 is switched off and S9 is switched on, the inverter should be connected to the power grid.

Procedure

Step 1 Log in to the EMMA on the local app and choose **Power adjustment > AS4777 > DRM** on the home screen.

Step 2 Set **DRM** to .

----End

7.3.6 Limit on Power Purchased from Grid

Function

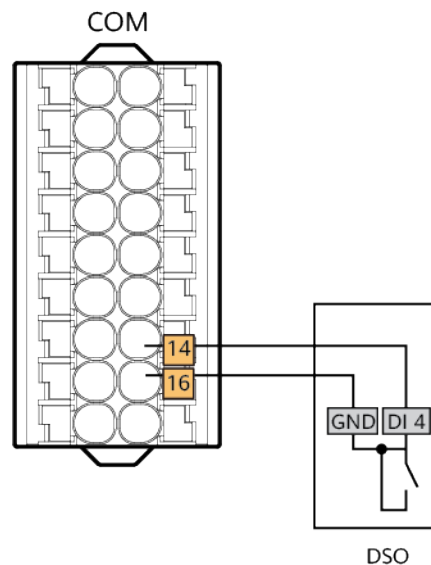
This function is used to control load power purchased from the grid. The power grid company uses the controller to transmit scheduling commands through the DI4 port. When the load power purchased from the grid is too high, it is limited. After the load capacity of the power grid recovers, the limit on the load power is removed.

NOTICE

Before setting this function, ensure that the inverter is correctly connected to the local DSO controller.

The following figure shows the cable connections between the inverter and the local DSO controller.

Figure 7-12 Cable connections



Procedure

1. **Connect to the EMMA on the app** and log in to the local commissioning screen of the device as an installer.
2. Choose **Power adjustment > Scheduling via DI Port** and enable **Limit on power purchased from grid**.
3. Tap **Submit**.

 NOTE

- If **Dry contact scheduling** has been enabled and the DI4 port has been configured, clear the DI4 port settings before enabling **Limit on power purchased from grid**. After **Limit on power purchased from grid** is enabled, the DI4 port is used to receive scheduling commands from the DSO and cannot be used for **Scheduling via DI Port** (in this case, the DI4 port is not displayed on the app).
- **ESS charge power from grid** and **Charge power of charger** refer to the maximum charge power of all ESSs and chargers in the current network, respectively.

7.3.7 Setting the Energy Measurement Mode

Function Description

This function is used to configure different energy measurement modes for different areas. After power meters are installed, you can configure the measurement modes to implement balanced and unbalanced measurement of energy.

 NOTE

Only the SUN2000-(5KTL-12KTL)-M1, SUN2000/SUN5000-(12K-25K)-MB0, SUN2000-(5K-12K)-MAP0, and SUN5000-(8K, 12K)-MAP0 series inverters support the energy measurement mode settings.

Procedure

1. [Connect to the EMMA on the app](#) and log in to the local commissioning screen of the device.
2. On the home screen, choose **Settings > Set Installation Parameters** and set **Energy Measurement Mode**.

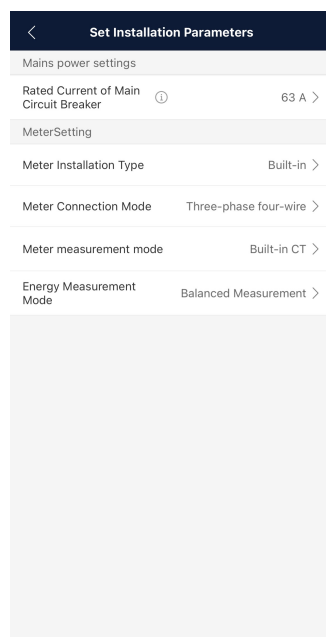


Table 7-12 Energy measurement mode

Parameter		Description
Energy Measurement Mode	Balanced Measurement	Default setting. The forward energy and reversing energy are respectively calculated by integrating the sum of power from three phases.
	Unbalanced Measurement	The forward energy and reversing energy are respectively calculated by integrating the power of each phase.

7.3.8 (Optional) Three-Phase Imbalance Control

Function Description

Three-phase imbalance control applies to the following scenarios:

- Asymmetric phase feeding with feed-in limitation: The feed-in power of each phase in the three-phase power grid cannot exceed the preset threshold. The inverter outputs different power for each phase based on the loads of each phase to ensure that the feed-in power of each phase does not exceed the preset threshold.
- PV+ESS asymmetric phase feeding for self-consumption: When the ESS discharges power to the loads, the inverter outputs phase-specific power based on the load of each phase and tracks the loads on each phase to ensure that no ESS discharge power is fed to the grid while the PV power can be fed to the grid.

The preceding two scenarios are supported concurrently.

NOTE

Three-phase imbalance control is supported in the EMMA networking scenario where only one inverter is applied or multiple inverters are connected in parallel.

Prerequisites

- Choose **Device monitoring > Inverter > Settings** and check that **Output mode** is set to **Three-phase, four-wire** and **Meter Connection Mode** in **Settings** is set to **Three-phase four-wire**.
- In the asymmetric phase feeding with feed-in limitation scenario, choose **Power adjustment > Limited Feed-in** and check that **Limitation mode** is set to **Single phase power**.
- In the PV+ESS asymmetric phase feeding for self-consumption scenario, choose **Power adjustment > Battery control** and check that **Working Mode** is set to **Maximum self-consumption** or **TOU**.

Procedure

1. Log in to the local commissioning screen.

2. Choose **Power adjustment > Split Phase Power Control** and set **Three-phase imbalance control** to **Enable**.

7.3.9 Resetting the Password for Logging In to the Local Commissioning Screen

If you forget the password for logging in to the local commissioning screen of the inverter, perform the following steps to reset the password:

Method 1: Connect to the device WLAN, obtain the verification code, and reset the password. For details, see [7.2.8.1 Resetting the Password After Connecting to the Device WLAN](#).

Method 2: Log in to the FusionSolar app, obtain the verification code, and connect to the device WLAN to reset the password. For details, see [7.2.8.2 Resetting the Password After Obtaining the Verification Code and Connecting to the Device WLAN](#).

NOTICE

- You can reset the login password of only one user at a time.
 - This function is supported by only the inverter series of SUN2000-(3K-6K)-LB0, SUN5000-(3K,6K)-LB0, SUN2000-(8K,10K)-LC0, SUN2000-(12K-25K)-MB0, SUN5000-(17K, 25K)-MB0, SUN2000-(5K-12K)-MAP0, and SUN5000-(8K, 12K)-MAP0.
-

7.3.9.1 Resetting the Password After Connecting to the Device WLAN

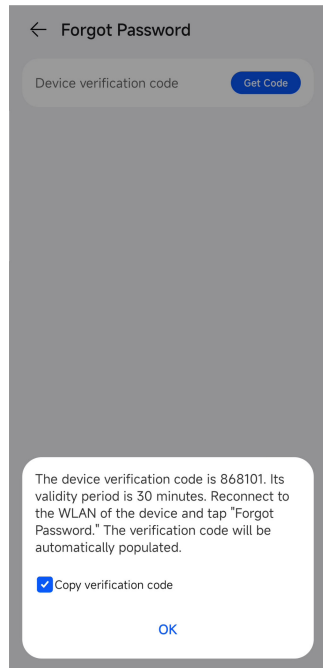
1. Log in to the FusionSolar app and choose **Services > Device Commissioning**.
2. [Connect to the WLAN of the EMMA](#) and access the **Log in** screen.
3. Select the user role whose password needs to be reset and tap **Forgot password?**
4. On the **Forgot Password** screen, tap **Get Code** and switch the network as prompted.
5. Enter the FusionSolar login password to obtain the verification code. After obtaining the verification code, tap **OK** and you will be redirected to the **Forgot Password** screen.
6. Enter the verification code, tap **OK**, and set a new password on the **Log in** screen as prompted.

NOTE

After the verification code is verified, set a new password within 10 minutes.

More Guidance

If the message in the following figure is displayed, tap **OK** to return to the device connection screen, reconnect to the device WLAN, access the **Forgot Password** screen again, and enter the verification code.

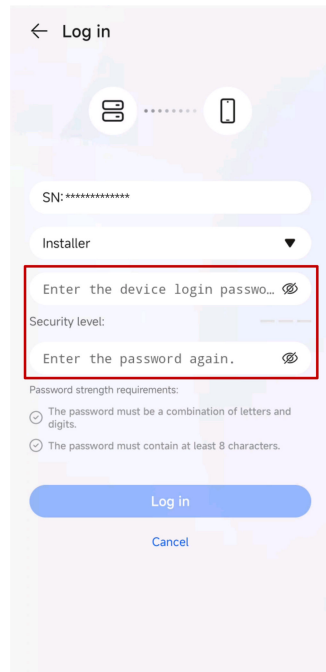


7.3.9.2 Resetting the Password After Obtaining the Verification Code and Connecting to the Device WLAN

1. Log in to the FusionSolar app and select the target plant on the home screen.
2. On the **Device** screen, choose **Inverter** > **:** > **O&M Authorization** > **Device verification code**.
3. On the **Device verification code** screen, tap **Get Code**, and enter the password for logging in to the FusionSolar to obtain a verification code.
4. Copy the verification code as prompted and tap **Proceed** to **connect to the WLAN of the EMMA**.
5. On the **Log in** screen, select the user whose password needs to be reset, tap **Forgot password?**, enter the verification code, and set a new password as prompted.

NOTE

After obtaining the verification code, set a new password within 10 minutes.



7.4 Viewing the Plant Creation Status

The FusionSolar app provides an overview of plants. You can view the plant running status, energy yield and consumption, revenue, and energy flow diagram in real time.

Log in to the app, tap **Home**, and tap **Plants**. This screen displays the real-time running status and basic information of all plants managed by the user by default.

Figure 7-13 Viewing the plant creation status



8 System Maintenance

DANGER

- Wear personal protective equipment and use dedicated insulated tools to avoid electric shocks or short circuits.

WARNING

- Before performing maintenance, power off the equipment, follow the instructions on the delayed discharge label, and wait for a period of time as specified to ensure that the equipment is not energized.

8.1 Routine Maintenance

To ensure that the inverter can operate properly for a long term, you are advised to perform routine maintenance on it as described in this section.

CAUTION

Power off the system before cleaning the system, connecting cables, and checking grounding reliability.

Table 8-1 Maintenance checklist

Check Item	Check Method	Maintenance Interval
System cleanliness	Check periodically whether the heat sinks are blocked or dirty.	Once every 6 to 12 months

Check Item	Check Method	Maintenance Interval
Cleanness of air intake and exhaust vents	Check periodically whether there is dust or foreign objects at the air intake and exhaust vents.	Power off the inverter and remove dust and foreign objects. If necessary, remove the baffle plates from the air intake and exhaust vents for cleaning. Once every 6 to 12 months (or once every 3 to 6 months based on the actual dust conditions in the environment)
System running status	<ul style="list-style-type: none"> • Check whether the inverter is damaged or deformed. • Check whether the inverter generates abnormal sound during operation. • Check whether all inverter parameters are correctly set during operation. 	Once every 6 months
Electrical connection	<ul style="list-style-type: none"> • Check whether cables are disconnected or loose. • Check whether cables are damaged, especially whether the cable sheath that contacts a metal surface is damaged. 	6 months after the first commissioning and once every 6 to 12 months after that
Grounding reliability	Check whether the PE cable is securely connected.	6 months after the first commissioning and once every 6 to 12 months after that
Sealing	Check whether all terminals and ports are properly sealed.	Once a year

8.2 System Power-Off

Precautions

WARNING

- After the system is powered off, the inverter is still energized and hot, which may cause electric shocks or burns. Therefore, wait for 5 minutes after power-off and then put on insulated gloves to operate the inverter.
 - Power off the system before maintaining optimizers and PV strings. Otherwise, electric shocks may occur when the PV strings are energized.
-

Procedure

- Step 1** Send a shutdown command on the app.
- Step 2** Turn off the AC switch between the inverter and the power grid.
- Step 3** Set the **DC SWITCH** to **OFF**.
- Step 4** (Optional) Install the padlock for the **DC SWITCH**. This step applies only to models used in Australia.
- Step 5** Turn off the DC switch between the inverter and PV strings.
- Step 6** (Optional) Turn off the battery switch on the battery.

----End

8.3 Troubleshooting

For details about alarms, see the [Inverter Alarm Reference](#).

8.4 Replacing an Inverter

- Step 1** Remove the inverter.
1. Power off the system. For details, see [8.2 System Power-Off](#).
 2. Disconnect all cables from the inverter, including signal cables, DC input power cables, battery cables, AC output power cables, and PE cables.
 3. Remove the inverter from the mounting bracket.
 4. Remove the mounting bracket.
- Step 2** Pack the inverter.
- If the original packaging is available, put the inverter inside it and then seal it using adhesive tape.
 - If the original packaging is unavailable, put the inverter inside a suitable hard cardboard box and seal it properly.

Step 3 Dispose of the inverter.

If the inverter reaches the end of its service life, dispose of it according to local regulations for the disposal of electrical equipment.

Step 4 Install a new inverter.

Step 5 Commission the inverter. For details, see [7 Power-On and Commissioning](#).

Step 6 Implement device replacement on the app.

1. Log in to the remote app and tap **Devices** on the home screen.

2. On the **Devices** screen, tap the name of the old device.

3. Tap **::** in the upper right corner and tap **Replace device**.

4. On the **Replace device** screen, tap  to scan the QR code of the new device or enter its SN.

5. Tap **Replace**.

----End

8.5 Locating Insulation Resistance Faults

If the ground resistance of a PV string connected to the inverter is too low, the inverter generates a **Low insulation resistance** alarm. The alarm ID is 2062.

The possible causes are as follows:

- A short circuit has occurred between the PV array and the ground.
- The ambient air of the PV array is damp and the insulation between the PV array and the ground is poor.

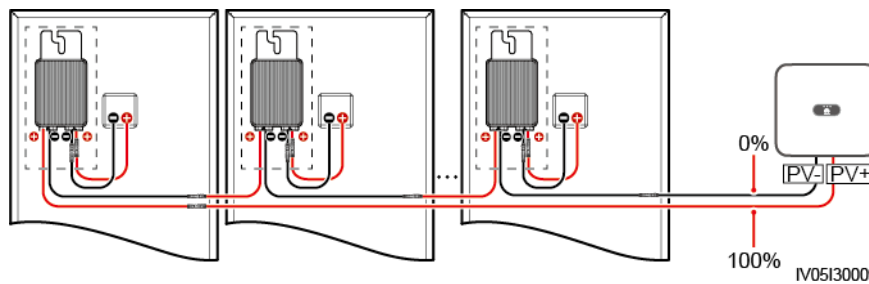
After the **Low insulation resistance** alarm is reported by the inverter, insulation resistance fault location is automatically triggered. If the fault location is successful, the location information is displayed on the **Alarm details** screen of the **Low insulation resistance** alarm on the FusionSolar app.

Log in to the FusionSolar app, choose **Alarm > Active alarm**, and choose **Low insulation resistance** to enter the **Alarm details** screen.

 NOTE

- The positive and negative terminals of a PV string are connected to the PV+ and PV- terminals of the inverter, respectively. The 0% position corresponds to the PV- terminal, and the 100% position corresponds to the PV+ terminal. Other percentages indicate that the fault occurs on a PV module or cable in the PV string.
- Possible fault position = Total number of PV modules in a PV string x Percentage of possible short-circuit positions. For example, if a PV string consists of 14 PV modules and the percentage of the possible short-circuit position is 34%, the possible fault position is 4.76 (14 x 34%), indicating that the fault is located near PV module 4, including the adjacent PV modules and their cables. The inverter has a detection precision of ±1 PV module.
- MPPT1 that may be faulty corresponds to PV1 and MPPT2 that may be faulty corresponds to PV2. The fault can be located only to the MPPT level. Perform the following steps to connect the PV strings corresponding to the faulty MPPT to the inverter one by one to further locate and rectify the fault.
- When a non-short-circuit fault occurs, the possible short-circuit percentage is not displayed. If the insulation resistance is greater than 0.001 MΩ, the fault is not related to short circuit. Check all PV modules in the faulty PV string one by one to locate and rectify the fault.

Figure 8-1 Percentage of short-circuit positions



Procedure

NOTICE

If the irradiance or the PV string voltage is too high, the insulation resistance fault location may fail. In this case, the fault location status on the **Alarm details** screen is **Conditions not met**. Perform the following steps to connect PV strings to the inverter one by one to locate the fault. If the system is not configured with any optimizer, skip the corresponding optimizer operations.

- Step 1** Ensure that the AC connections are normal. Log in to the FusionSolar app, choose **Maintenance > Inverter ON/OFF** on the home screen, and send a shutdown command. Set **DC SWITCH** to **OFF**.
- Step 2** Connect one PV string to the inverter, and set **DC SWITCH** to **ON**. If the inverter status is **Shutdown: Command**, log in to the app, choose **Maintenance > Inverter ON/OFF** on the home screen, and send a startup command.
- Step 3** Choose **Alarm** on the home screen, enter the **Active alarm** screen, and check whether a **Low insulation resistance** alarm is reported.
 - If no **Low insulation resistance** alarm is reported 1 minute after the DC side is powered on, choose **Maintenance > Inverter ON/OFF** on the home screen,

and send a shutdown command. Set **DC SWITCH** to **OFF**. Go to [Step 2](#) and check rest of the PV strings one by one.

- If a **Low insulation resistance** alarm is reported 1 minute after the DC side is powered on, check the percentage of possible short-circuit positions on the **Alarm details** screen and calculate the location of the possible faulty PV module based on the percentage. Then go to [Step 4](#).

Step 4 Log in to the app, choose **Maintenance > Inverter ON/OFF** on the home screen, and send a shutdown command. Set **DC SWITCH** to **OFF**. Check whether the connectors or DC power cables between the optimizer and PV module, between adjacent PV modules, or between adjacent optimizers on the possible fault position are damaged.

- If yes, replace the damaged connectors or DC power cables, and then set **DC SWITCH** to **ON**. If the inverter status is **Shutdown: Command**, choose **Maintenance > Inverter ON/OFF**, and send a startup command. View alarm information.
 - If no **Low insulation resistance** alarm is reported 1 minute after the DC side is powered on, troubleshoot the insulation resistance fault of the PV string. Log in to the app, choose **Maintenance > Inverter ON/OFF** on the home screen, and send a shutdown command. Set **DC SWITCH** to **OFF**. Go to [Step 2](#) and check rest of the PV strings one by one. Then, go to [Step 8](#).
 - If the DC side is powered on 1 minute later, the **Low insulation resistance** alarm is still reported. Log in to the app, choose **Maintenance > Inverter ON/OFF** on the home screen, and send a shutdown command. Set **DC SWITCH** to **OFF** and go to [Step 5](#).
- If no, go to [Step 5](#).

Step 5 Disconnect the possible faulty PV module and the paired optimizer from the PV string, and use a DC extension cable with an MC4 connector to connect the PV module or optimizer adjacent to the possible faulty PV module. Set **DC SWITCH** to **ON**. If the inverter status is **Shutdown: Command**, choose **Maintenance > Inverter ON/OFF** on the home screen, and send a startup command. View alarm information.

- If no **Low insulation resistance** alarm is reported 1 minute after the DC side is powered on, the fault occurred on the disconnected PV module and optimizer. Choose **Maintenance > Inverter ON/OFF**, send a shutdown command, and set **DC SWITCH** to **OFF**. Go to [Step 7](#).
- If the **Low insulation resistance** alarm is reported 1 minute after the DC side is powered on, the fault did not occur on the disconnected PV module and optimizer. Go to [Step 6](#).

Step 6 Log in to the app, choose **Maintenance > Inverter ON/OFF** on the home screen, and send a shutdown command. Set **DC SWITCH** to **OFF**, reconnect the disconnected PV module and optimizer, and repeat [Step 5](#) to check the PV modules and optimizers adjacent to the possible fault location.

Step 7 Determine the position of the ground insulation fault:

- Disconnect the possible faulty PV module from the optimizer.
- Connect the possible faulty optimizer to the PV string.

- Set **DC SWITCH** to **ON**. If the inverter status is **Shutdown: Command**, choose **Maintenance > Inverter ON/OFF**, and send a startup command. View alarm information.
 - If no **Low insulation resistance** alarm is reported 1 minute after the DC side is powered on, the fault is on the possible faulty PV module.
 - If the **Low insulation resistance** alarm is reported 1 minute after the DC side is powered on, the fault is on the possible faulty optimizer.
- Log in to the app, choose **Maintenance > Inverter ON/OFF** on the home screen, and send a shutdown command. Set **DC SWITCH** to **OFF**, replace the faulty component, and complete troubleshooting the insulation resistance fault. Go to [Step 2](#) and check rest of the PV strings one by one. Then, go to [Step 8](#).

Step 8 Set **DC SWITCH** to **ON**. If the inverter status is **Shutdown: Command**, choose **Maintenance > Inverter ON/OFF**, and send a startup command.

----End

9 Technical Specifications

Efficiency

Item	SUN5000-8K-MAP0	SUN5000-12K-MAP0
Maximum efficiency ^a	98.60%	98.60%
European efficiency ^a	98.00%	98.20%
Note a: The efficiency test condition is three-phase three-wire mode.		

Input

Item	SUN5000-8K-MAP0	SUN5000-12K-MAP0
Recommended maximum input DC power	14,600 W	22,000 W
Maximum input voltage ^b	1100 V	
Maximum input current per MPPT	16 A	
Maximum short-circuit current per MPPT	22 A	
Minimum startup voltage	160 V	
MPPT voltage range ^c	160–1000 V	
Full-load MPPT voltage range	400–850 V	400–850 V
Rated input voltage	600 V	
Maximum number of inputs	2	

Item	SUN5000-8K-MAP0	SUN5000-12K-MAP0
Number of MPPT circuits	2	
Rated battery voltage	600 V DC	
Battery voltage range	600–980 V DC	
Maximum battery current	20 A	
Battery type	Li-ion	
<p>Note b: The maximum input voltage is the maximum DC input voltage that the inverter can withstand. If the input voltage exceeds this value, the inverter may be damaged.</p> <p>Note c: If the input voltage is beyond the MPPT voltage range, the inverter cannot work properly.</p>		

Output

Item	SUN5000-8K-MAP0	SUN5000-12K-MAP0
Rated output power	8000 W	12,000 W
Maximum apparent power	8800 VA	13,200 VA
Maximum active power (cos ϕ = 1)	8800 W	13,200 W
Rated output voltage	220 V/380 V, 3W/N+PE 230 V/400 V, 3W/N+PE 240 V/415 V, 3W/N+PE	
Maximum output voltage at long-term operation	Refer to the local power grid standards.	
Rated output current	12.1 A/380 V 11.6 A/400 V 11.1 A/415 V	18.2 A/380 V 17.3 A/400 V 16.7 A/415 V
Maximum output current	13.3 A/380 V 12.8 A/400 V 12.2 A/415 V	20.2 A/380 V 19.1 A/400 V 18.5 A/415 V
Overload output power	150% load (single-phase): 5 minutes 200% load (single-phase): 10 seconds	
Maximum input current	12.1 A	18.2 A

Item	SUN5000-8K-MAP0	SUN5000-12K-MAP0
Output voltage frequency	50 Hz/60 Hz	
Power factor	0.8 leading ... 0.8 lagging	
Output DC component (DCI)	< 0.25% of the rated output	
Maximum total harmonic distortion (AC THDi)	< 3% (rated conditions)	

Off-grid Output

Item	SUN5000-8K-MAP0	SUN5000-12K-MAP0
Rated output voltage	220 V/380 V, 3W/N+PE 230 V/400 V, 3W/N+PE 240 V/415 V, 3W/N+PE	
Rated output frequency	50 Hz/60 Hz	
Rated output power	8000 W	12,000 W
Long-term load power	8800 W	13,200 W
Overload output power	110% load (three-phase): long-term operation 150% load (three-phase): 5 minutes 150% load (single-phase): 5 minutes 200% load (three-phase): 10 seconds	110% load (three-phase): long-term operation 150% load (three-phase): 1 minute 150% load (single-phase): 5 minutes 200% load (three-phase): 10 seconds

Protection

Item	SUN5000-8K-MAP0	SUN5000-12K-MAP0-
Overvoltage category	PV II/AC III	
Input DC switch	Supported	
Anti-islanding protection	Supported	
Output overcurrent protection	Supported	

Item	SUN5000-8K-MAP0	SUN5000-12K-MAP0-
Input reverse connection protection	Supported	
DC surge protection	TYPE II	
AC surge protection	Yes, compatible with TYPE II protection class according to EN/IEC 61643-11	
Insulation resistance detection	Supported	
Residual current monitoring unit (RCMU)	Supported	

Display and Communication

Item	SUN5000-8K-MAP0	SUN5000-12K-MAP0
Display	LED indicators; WLAN+app	
WLAN-FE Smart Dongle	Supported	
4G Smart Dongle	Supported	
EMMA	Supported	
SmartGuard	Supported	
RS485 communication	Supported	
Built-in WLAN	Supported	
DC MBUS	Supported	
AFCI	Supported	
PID recovery	Supported	

General Specifications

Item	SUN5000-8K-MAP0	SUN5000-12K-MAP0
Dimensions (W x H x D)	490 mm x 460 mm x 130 mm	
Net weight	≤ 21 kg	
Noise	≤ 29 dB (typical working condition)	
Operating temperature	-25°C to +60°C	
Relative humidity	0-100% RH	

Item	SUN5000-8K-MAP0	SUN5000-12K-MAP0
Cooling mode	Natural cooling	
Maximum operating altitude	4000 m (derated when the altitude is greater than 2000 m)	
Storage temperature	-40°C to +70°C	
IP rating	IP66	
Topology	Transformerless	

Wireless Communication Specifications

Item	Inverter Built-in WiFi
Frequency	2400–2483.5 MHz
Protocol standard	WLAN 802.11b/g/n
Bandwidth	≤ 20 MHz
Maximum transmit power	≤ 20 dBm EIRP

A Grid Codes

 NOTE

The grid codes are subject to change. The listed codes are for reference only.

Table A-1 SUN5000-(8K, 12K)-MAP0 grid codes

No.	Grid Code	Description	SUN5000-8K-MAP0	SUN5000-12K-MAP0
1	VDE-AR-N-4105	Germany/Hungary power grid	Supported	Supported
2	UTE C 15-712-1(A)	France mainland power grid	Supported	Supported
3	UTE C 15-712-1(B)	France island power grid	Supported	Supported
4	UTE C 15-712-1(C)	France island power grid	Supported	Supported
5	CEI0-21	Italy power grid	Supported	Supported
6	IEC 61727	IEC 61727 low-voltage grid-connection (50 Hz)	Supported	Supported
7	Philippines	Philippines low-voltage power grid	Supported	Supported
8	NRS-097-2-1	South Africa standard power grid	Supported	Supported
9	IEC 61727 - 60 Hz	IEC 61727 low-voltage grid-connection (60 Hz)	Supported	Supported
10	DUBAI	Dubai low-voltage power grid	Supported	Supported

No.	Grid Code	Description	SUN5000-8K-MAP0	SUN5000-12K-MAP0
11	Jordan-Distribution	Jordan power distribution network low-voltage power grid	Supported	Supported
12	TAIPOWER	Taiwan Power low-voltage power grid	Supported	Supported
13	Oman	Oman low-voltage power grid	Supported	Supported
14	Pakistan	Pakistan power grid	Supported	Supported
15	G99-TYPEA-LV	UK G99-TYPEA-LV	-	Supported
16	G98	UK G98	Supported	-
17	RD1699/661	Spain power grid	Supported	Supported
18	NTS	Spain power grid	Supported	Supported
19	PO12.3	Spain power grid	Supported	Supported
20	SINGAPORE	Singapore low-voltage power grid	Supported	Supported
21	HONGKONG	Hong Kong low-voltage power grid	Supported	Supported
22	EN50549-SE	Sweden power grid	Supported	Supported
23	EN50549-PL	Poland power grid	Supported	Supported
24	EN50549-LV	Türkiye power grid	Supported	Supported
25	DENMARK-EN50549-DK1-LV230	Denmark power grid	Supported	Supported
26	DENMARK-EN50549-DK2-LV230	Denmark power grid	Supported	Supported
27	SWITZERLAND-NA/EEA:2020-LV230	Switzerland power grid	Supported	Supported
28	AUSTRALIA-AS4777_A-LV230	Australia power grid	Supported	Supported
29	AUSTRALIA-AS4777_B-LV230	Australia power grid	Supported	Supported
30	AUSTRALIA-AS4777_C-LV230	Australia power grid	Supported	Supported
31	AUSTRALIA-AS4777_NZ-LV230	New Zealand power grid	Supported	Supported

No.	Grid Code	Description	SUN5000-8K-MAP0	SUN5000-12K-MAP0
32	AS4777	New Zealand power grid	Supported	Supported
33	CZECH-EN50549-LV230	Czech Republic power grid	Supported	Supported
34	Israel	Israel power grid	Supported	Supported
35	FINLAND-EN50549-LV230	Finland power grid	Supported	Supported
36	ANRE	Romania low-voltage power grid	Supported	Supported
37	NEW CALEDONIA-LV230	New Caledonia power grid	Supported	Supported
38	NC2022	New Caledonia power grid	Supported	Supported
39	Austria	Austria power grid	Supported	Supported
40	KUWAIT	Kuwait power grid	Supported	Supported
41	BAHRAIN	Bahrain power grid	Supported	Supported
42	SAUDI	Saudi Arabia power grid	Supported	Supported
43	LEBANON	Lebanon power grid	Supported	Supported
44	NB/T 32004	China Golden Sun low-voltage power grid	Supported	Supported
45	CHINA-LV220/380	China low-voltage power grid	Supported	Supported
46	Island-Grid	Grid code for off-grid operation	Supported	Supported
47	Custom (50 Hz)	Reserved	Supported	Supported
48	Custom (60 Hz)	Reserved	Supported	Supported

B Connecting to the Inverter on the App

NOTICE

- When directly connecting your phone to a device, ensure that your phone is within the WLAN coverage of the device.
- When connecting the device to the router over WLAN, ensure that the device is within the WLAN coverage of the router and the signal is stable and good.
- The router supports WLAN (IEEE 802.11 b/g/n, 2.4 GHz) and the WLAN signal reaches the inverter.
- The WPA, WPA2, or WPA/WPA2 encryption mode is recommended for routers. The Enterprise mode is not supported (such as airport WLAN and other public hotspots that require authentication). WEP and WPA TKIP are not recommended because they have serious security vulnerabilities. If the access fails in WEP mode, log in to the router and change the encryption mode of the router to WPA2 or WPA/WPA2.

Step 1 Start device commissioning.

Figure B-1 Method 1: mobile phone connected to the Internet

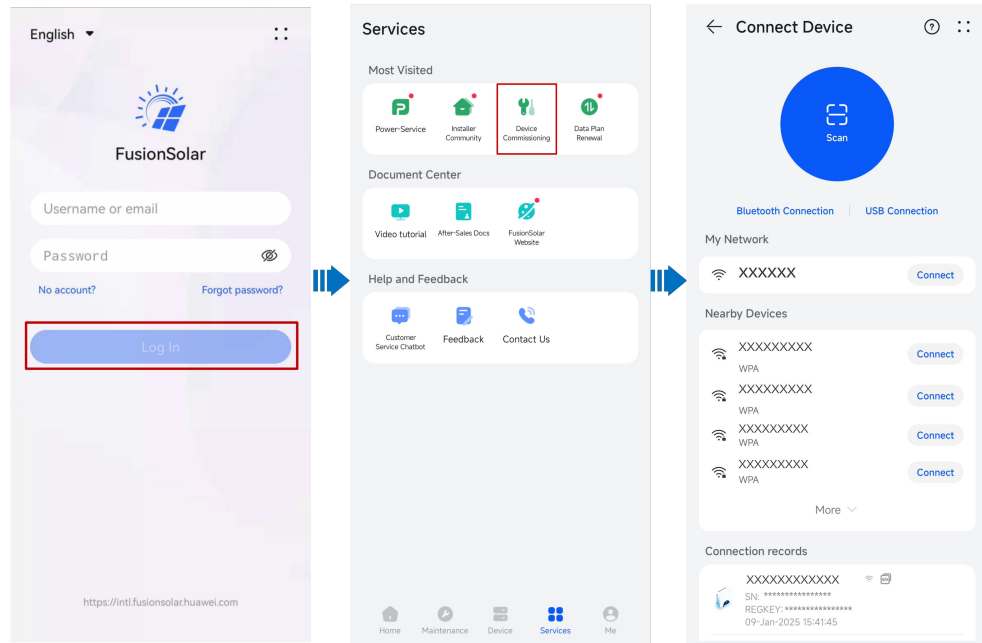
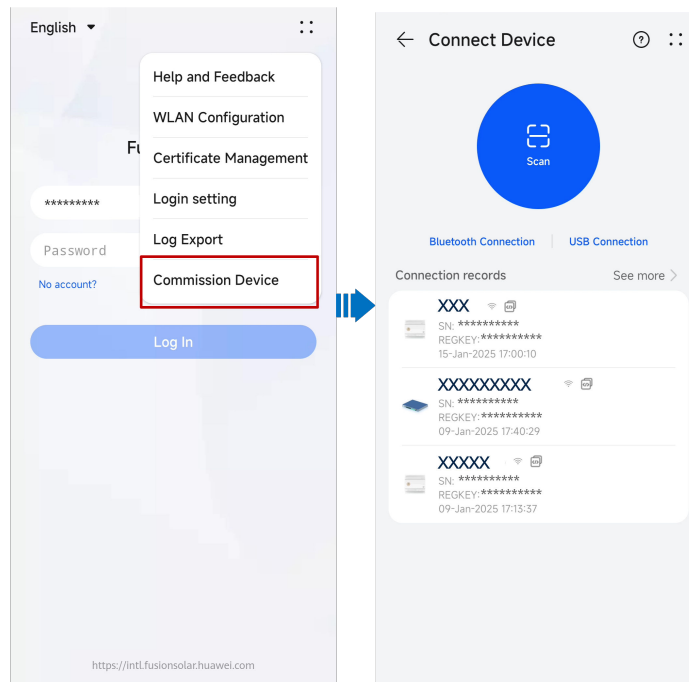


Figure B-2 Method 2: mobile phone not connected to the Internet



NOTE

Method 2 can be used only when no Internet access is available. You are advised to log in to the FusionSolar app to commission devices using method 1.

Step 2 Connect to the inverter WLAN.

Tap **Scan**. On the QR code scanning screen, align the QR code with the scanning box to automatically scan and connect to the WLAN of the inverter.

 NOTE

- The WLAN name of a product consists of "Device name-Product SN." (The last six digits of the WLAN name of some products are the same as the last six digits of the product SN.)
- Use the initial password for the first connection. You can obtain the initial WLAN password from the label on the device.
- Ensure account security by changing the password periodically. Your password might be stolen or cracked if it is left unchanged for extended periods. If a password is lost, the device cannot be accessed. In these cases, the Company shall not be liable for any loss.
- If the login screen is not displayed after you scan the QR code, check whether your phone is correctly connected to the device WLAN. If not, manually select and connect to the WLAN.
- If the message **This WLAN network has no Internet access. Connect anyway?** is displayed when you connect to the built-in WLAN, tap **CONNECT**. Otherwise, you cannot log in to the system. The actual UI and messages may vary with mobile phones.

Step 3 Log in to the device commissioning screen as **Installer**.

NOTICE

- After completing the deployment settings, the installer should remind the owner to access the local commissioning screen of the device and set the login password of the owner account as prompted.
- Ensure account security by changing the password periodically. Your password might be stolen or cracked if it is left unchanged for extended periods. If a password is lost, the device cannot be accessed. In these cases, the Company shall not be liable for any loss.

----End

C Connecting to the EMMA on the App

NOTICE

- When directly connecting your phone to a device, ensure that your phone is within the WLAN coverage of the device.
- When connecting the device to the router over WLAN, ensure that the device is within the WLAN coverage of the router and the signal is stable and good.
- The router supports WLAN (IEEE 802.11 b/g/n, 2.4 GHz) and the WLAN signal reaches the inverter.
- The WPA, WPA2, or WPA/WPA2 encryption mode is recommended for routers. The Enterprise mode is not supported (such as airport WLAN and other public hotspots that require authentication). WEP and WPA TKIP are not recommended because they have serious security vulnerabilities. If the access fails in WEP mode, log in to the router and change the encryption mode of the router to WPA2 or WPA/WPA2.

Step 1 Start device commissioning.

Figure C-1 Method 1: mobile phone connected to the Internet

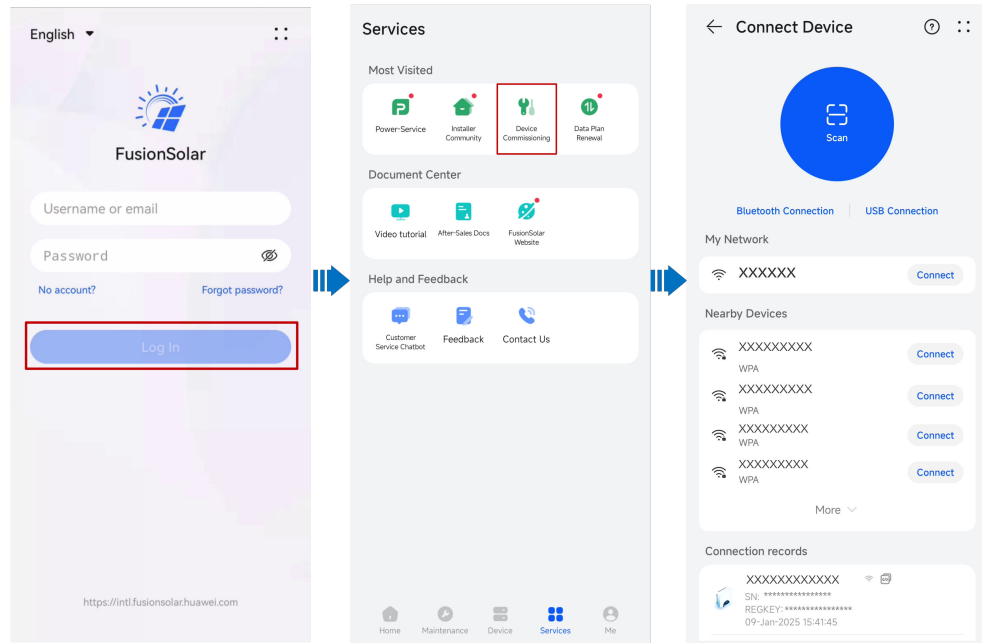
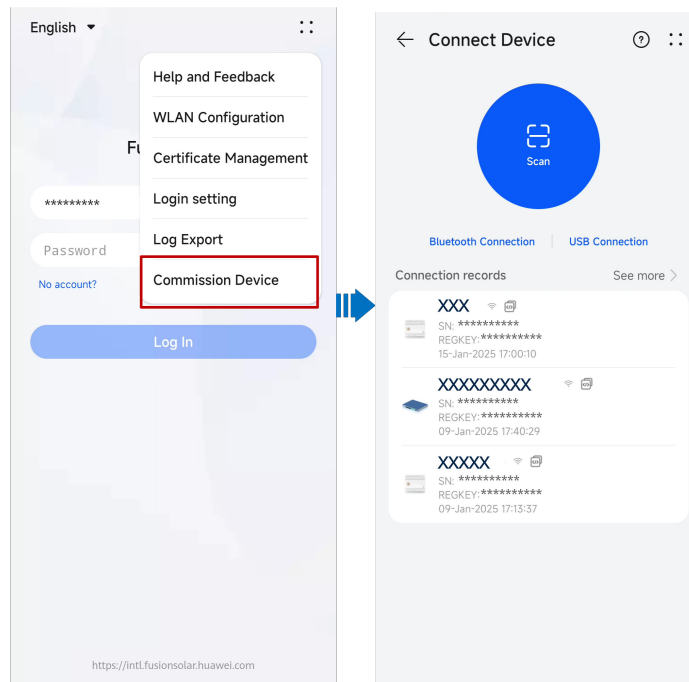


Figure C-2 Method 2: mobile phone not connected to the Internet



NOTE

Method 2 can be used only when no Internet access is available. You are advised to log in to the FusionSolar app to commission devices using method 1.

Step 2 Connect to the WLAN of the EMMA.

Tap **Scan**. On the QR code scanning screen, align the QR code with the scanning box to automatically scan and connect to the WLAN of the EMMA.

 **NOTE**

- EMMA networking: Scan the WLAN QR code of the EMMA.
- SmartGuard networking: Scan the WLAN QR code of the SmartGuard or EMMA.

 **NOTE**

- The WLAN name of a product consists of "Device name-Product SN." (The last six digits of the WLAN name of some products are the same as the last six digits of the product SN.)
- For the first connection, log in with the initial password. You can obtain the initial WLAN password from the label on the device.
- Ensure account security by changing the password periodically. Your password might be stolen or cracked if it is left unchanged for extended periods. If a password is lost, the device cannot be accessed. In these cases, the Company shall not be liable for any loss.
- If the login screen is not displayed after you scan the QR code, check whether your phone is correctly connected to the device WLAN. If not, manually select and connect to the WLAN.
- If the message **This WLAN network has no Internet access. Connect anyway?** is displayed when you connect to the built-in WLAN, tap **CONNECT**. Otherwise, you cannot log in to the system. The actual UI and messages may vary with mobile phones.





Step 3 Log in to the device commissioning screen as **Installer**.

NOTICE

- After completing the deployment settings, the installer shall remind the owner to access the local commissioning screen of the device and set the login password of the owner account as prompted.
- To ensure account security, protect the password by changing it periodically, and keep it secure. Your password might be stolen or cracked if it is left unchanged for extended periods. If a password is lost, devices cannot be accessed. In these cases, the Company shall not be liable for any loss.

----End

D Resetting the Login Password on the Hardware

- Step 1** Check that the AC and DC sides of the inverter are both powered on, and indicators  and  are steady green or blinking slowly for more than 3 minutes.
- Step 2** Turn off the AC switch, set the DC SWITCH at the bottom of the inverter to OFF, and wait until all indicators on the inverter panel turn off.
- Step 3** Complete the following operations within 4 minutes:
1. Turn on the AC switch and wait for about 90s or until the inverter indicator  blinks.
 2. Turn off the AC switch and wait about 30s or until all LED indicators on the inverter panel turn off.
 3. Turn on the AC switch and wait for about 30s or until all LED indicators on the inverter panel blink and then turn off after about 30s.
- Step 4** Wait until the three green LEDs on the inverter panel blink fast and then the three red LEDs blink fast, which indicates that the password is restored.
- Step 5** Reset the password within 10 minutes. (If no operation is performed within 10 minutes, all parameters of the inverter remain unchanged.)
1. Wait until the indicator  blinks.
 2. Connect to the app using the initial WLAN hotspot name (SSID) and initial password (PSW), which can be obtained from the label on the side of the inverter.
 3. On the login page, set a new password and log in to the app.
- Step 6** Set router and management system parameters to implement remote management.

----End

NOTICE

You are advised to reset the password in the morning or at night when the solar irradiance is low.

E Rapid Shutdown

NOTE

- If method 3 is selected for rapid shutdown, log in to the FusionSolar app as an **installer** user to perform local commissioning, choose **Settings > Feature parameters > Dry contact function**, and set **Dry contact function** to **DI rapid shutdown**.
- The rapid shutdown function is supported only if optimizers are configured for all PV modules.

If optimizers are configured for all PV modules, the PV system can perform a rapid shutdown to decrease the output voltage to below 30 V within 30s.

Perform the following steps to trigger a rapid shutdown:

- Method 1: Turn off the AC switch between the inverter and the power grid (disconnect the voltages of all PV strings connected to the inverter under the AC switch).
- Method 2: Set the **DC SWITCH** of the inverter to **OFF** to trigger a rapid shutdown. The inverter shuts down several minutes later. (Turning off all external switches on the DC side of an inverter can trigger a rapid shutdown, and only the PV strings connected to the inverter is de-energized. Turning off only some external switches cannot trigger a rapid shutdown, and the PV strings may be energized.)
- Method 3: To enable the DI rapid shutdown function, connect a switch to pins DI and GND of the inverter communications terminal. The switch is turned on by default. Turn off the switch to trigger a rapid shutdown. The distance between the switch and the farthest inverter must be less than or equal to 10 m.
- Method 4: If **AFCI** is enabled, the inverter automatically performs arc fault detection and triggers a rapid shutdown when AFCI lock protection is implemented.

F Baud Rate Negotiation

Baud rate negotiation increases the communications rate between the inverter and devices such as batteries and power meters, and between the inverter and devices such as the Smart Dongles and the EMMA, solving or relieving communication congestion.

- During device search in a new plant, the system automatically negotiates the baud rate.
- When replacing or adding inverters, batteries, power meters, the Smart Dongle, or the EMMA at an existing plant, you need to manually send local commands on the FusionSolar app to reset the baud rate between devices and negotiate a higher rate.

 **NOTE**

Users can send the baud rate negotiation commands on the FusionSolar app in two networking modes: EMMA networking and Smart Dongle networking.

Table F-1 Manual baud rate negotiation on the app

Networking Mode	Scenario	Operation
EMMA networking	Replacing the EMMA	<ol style="list-style-type: none"> 1. Use the FusionSolar app to locally scan the QR code to connect to the EMMA. 2. Access the Communication settings screen, choose RS485 Settings > Baud Rate Negotiation, and tap 9600 and Negotiate a higher rate.

Networking Mode	Scenario	Operation
	Replacing or adding an inverter	<ol style="list-style-type: none"> 1. Use the FusionSolar app to locally scan the QR code to connect to the EMMA. 2. Access the Communication settings screen, choose RS485 Settings > Baud Rate Negotiation, and tap 9600 and Negotiate a higher rate. 3. Use the FusionSolar app to locally scan the QR code to connect to the inverter. 4. Access the Communication configuration screen, choose RS485 > Baud Rate Negotiation > RS485_2 > Baud Rate Negotiation, and tap 9600 and Negotiate a higher rate.
	Replacing or adding an RS485_2 device (such as a battery or power meter)	<ol style="list-style-type: none"> 1. Use the FusionSolar app to locally scan the QR code to connect to the inverter. 2. Access the Communication configuration screen, choose RS485 > Baud Rate Negotiation > RS485_2 > Baud Rate Negotiation, and tap 9600 and Negotiate a higher rate.
Smart Dongle networking	Replacing the Smart Dongle	<ol style="list-style-type: none"> 1. Use the FusionSolar app to locally scan the QR code to connect to the inverter. 2. Access the Communication configuration screen, choose RS485 > Baud Rate Negotiation > RS485_1 > Baud Rate Negotiation, and tap 9600 and Negotiate a higher rate.

Networking Mode	Scenario	Operation
	Replacing or adding an inverter	<ol style="list-style-type: none"> 1. Use the FusionSolar app to locally scan the QR code to connect to the inverter. 2. Access the Communication configuration screen, choose RS485 > Baud Rate Negotiation > RS485_1 > Baud Rate Negotiation, and tap 9600 and Negotiate a higher rate. 3. Access the Communication configuration screen, choose RS485 > Baud Rate Negotiation > RS485_2 > Baud Rate Negotiation, and tap 9600 and Negotiate a higher rate.
	Replacing or adding an RS485_2 device (such as a battery or power meter)	<ol style="list-style-type: none"> 1. Use the FusionSolar app to locally scan the QR code to connect to the inverter. 2. Access the Communication configuration screen, choose RS485 > Baud Rate Negotiation > RS485_2 > Baud Rate Negotiation, and tap 9600 and Negotiate a higher rate.

Troubleshooting

If manual baud rate negotiation fails, refer to the following troubleshooting measures.

Table F-2 Troubleshooting measures

Scenario	Troubleshooting
Negotiation failed	<ol style="list-style-type: none"> 1. Check whether the device cables are connected properly. If no, connect the device cables correctly. 2. Check whether service operations such as upgrade and log export are performed on the management system. If yes, perform baud rate negotiation again after such operations are complete. 3. To replace an RS485_2 device (such as a battery or power meter), choose Maintenance > Subdevice management on the home screen, touch and hold the replaced RS485_2 device to delete it. 4. Perform baud rate negotiation again. 5. When replacing or adding an inverter or an RS485_2 device (such as a battery or power meter), if you tap Negotiate a higher rate and a message "Negotiation failed. The southbound device does not support the rate." is displayed, it indicates that the device does not support baud rate negotiation. In this case, you only need to tap 9600. 6. If the fault persists, contact your vendor.

G Contact Information

If you have any questions about this product, please contact us.



<https://digitalpower.huawei.com>

Path: **About Us > Contact Us > Service Hotlines**

To ensure faster and better services, we kindly request your assistance in providing the following information:

- Model
- Serial number (SN)
- Software version
- Alarm ID or name
- Brief description of the fault symptom

 **NOTE**

EU Representative Information: Huawei Technologies Hungary Kft.
Add.: HU-1133 Budapest, Váci út 116-118., 1. Building, 6. floor.
Email: hungary.reception@huawei.com

H Digital Power Customer Service



<https://digitalpower.huawei.com/robotchat/>

Certificate Management and Maintenance

I.1 Initial Certificate Risk Disclaimer

Huawei's initial certificates are mandatory identity credentials for Huawei devices before delivery. The disclaimer statements for using the certificates are as follows:

1. Huawei's initial certificates are used only in the deployment phase, for establishing initial security channels between devices and the customer's network. Huawei does not promise or guarantee the security of the initial certificates.
2. Customers shall bear consequences of all security risks and security incidents arising from using Huawei's initial certificates as service certificates.
3. Huawei's initial certificates are valid from the manufacturing date until December 29, 2099.
4. Services using an initial certificate will be interrupted when the certificate expires.
5. It is recommended that customers deploy a PKI system to issue certificates for devices and software on the live network and manage the lifecycle of the certificates. To ensure security, certificates with short validity periods are recommended.

NOTE

You can view the validity period of an initial certificate on the network management system.

I.2 Application Scenarios of Initial Certificates

File Path and Name	Scenario	Replacement
f:/app_ca.crt	Authenticates the validity of the peer mobile app for communication through Modbus TCP.	For details about how to replace a certificate, contact technical support engineers to obtain the corresponding security maintenance manual. Certificates for communication between the Company's products can be replaced.
f:/app_tomcat_client.crt		
f:/app_tomcat_client.key		

J Acronyms and Abbreviations

A	
AFCI	Arc-fault Circuit Interrupter
L	
LED	Light Emitting Diode
M	
MPP	Maximum Power Point
MPPT	Maximum Power Point Tracking
P	
PE	Protective Earthing
PID	Potential Induced Degradation
PV	Photovoltaic
R	
RH	Relative Humidity
S	
SOC	State of Charge